

Telemetry Module MT-101

CE

User Manual

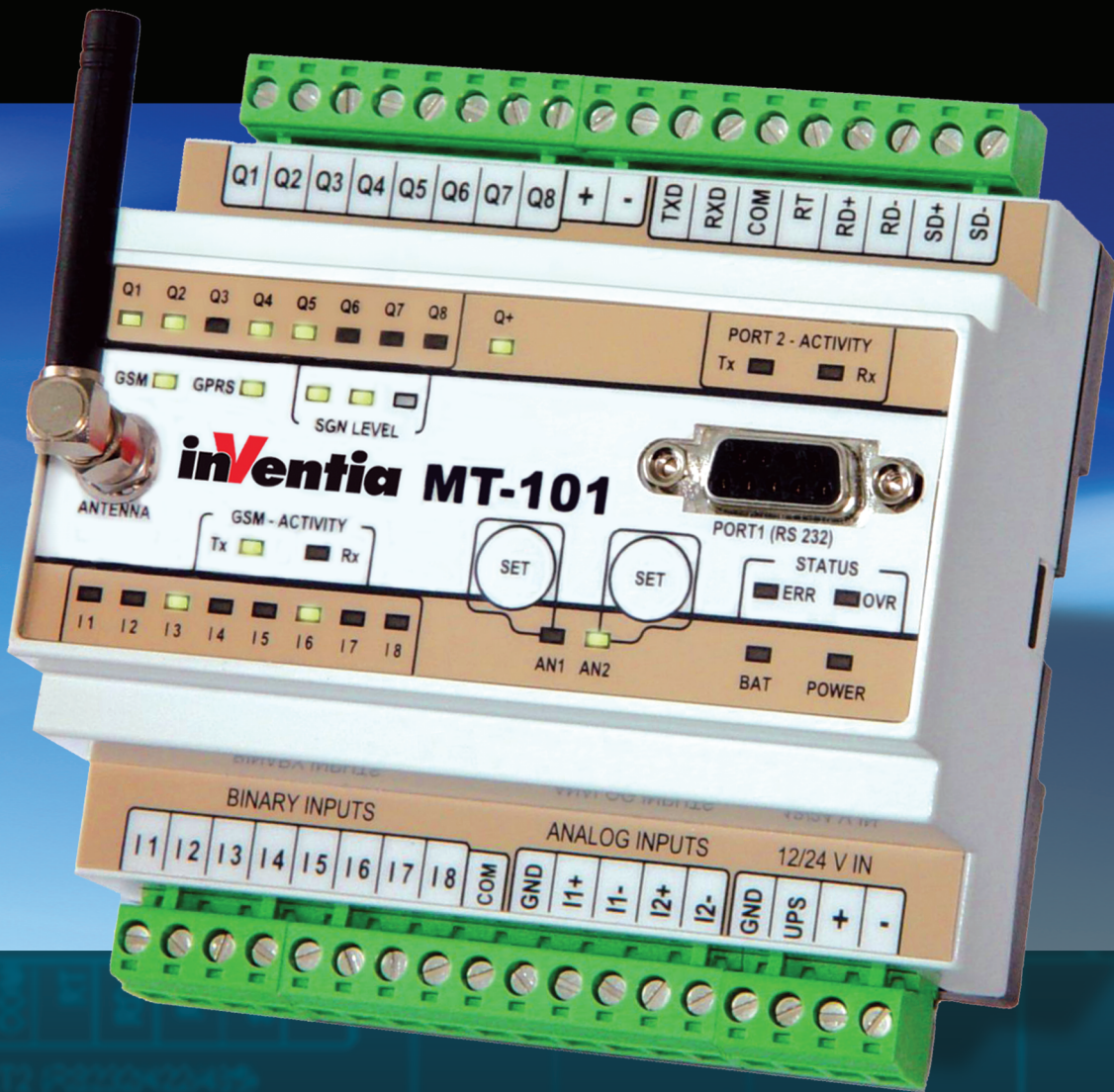

Moduł Telemetryczny MT-101

Instrukcja Obsługi

Moduł telemetryczny GSM/GPRS
do zdalnego monitorowania i sterowania

Końcowe urządzenie telekomunikacyjne
klasy 1 GSM 850/900/1800/1900

MT-101

© 2010 Inventia Sp. z o.o.

Wszelkie prawa zastrzeżone. Żaden fragment niniejszego dokumentu nie może być powielany lub kopiowany w żadnej formie bez względu na stosowaną technologię – graficzną, elektroniczną lub mechaniczną, włączając fotokopiowanie i/lub zapis cyfrowy, również w systemach przechowywania i wyszukiwania dokumentów – bez pisemnej zgody Wydawcy.

Nazwy produktów wymienionych w niniejszym dokumencie mogą być Znakami Towarowymi i/lub zastrzeżonymi Znakami Towarowymi należącymi do odpowiednich Właścicieli. Wydawca i Autor oświadczają, że nie roszczą do tych znaków towarowych żadnych praw.

Pomimo, że niniejsze opracowanie tworzone było z zachowaniem wszelkiej należytej staranności, zarówno Wydawca jak i Autor nie ponoszą żadnej odpowiedzialności za błędy lub pominięcia w jego treści jak również za straty wynikłe z wykorzystania zawartej w niniejszym opracowaniu informacji lub ewentualnie towarzyszącego jej oprogramowania. W żadnym wypadku Wydawca lub Autor nie będą odpowiedzialni za utratę zysku lub inne straty, w tym handlowe, spowodowane lub rzekomo związane, bezpośrednio lub pośrednio, z niniejszym opracowaniem.

All rights reserved. No parts of this work may be reproduced in any form or by any means - graphic, electronic, or mechanical, including photocopying, recording, taping, or information storage and retrieval systems - without the written permission of the publisher.

Products that are referred to in this document may be either trademarks and/or registered trademarks of the respective owners. The publisher and the author make no claim to these trademarks.

While every precaution has been taken in the preparation of this document, the publisher and the author assume no responsibility for errors or omissions, or for damages resulting from the use of information contained in this document or from the use of programs and source code that may accompany it. In no event shall the publisher and the author be liable for any loss of profit or any other commercial damage caused or alleged to have been caused directly or indirectly by this document.

Publisher:

INVENTIA Sp. z o.o.
ul. Kulczyńskiego 14
02-777 Warszawa
Tel: +48 22 545-32-00
inventia@inventia.pl
www.inventia.pl

Version:

1.46
Warsaw, June 2010

MTC Compatibility:

1.46

Index

1. Introduction	9
2. Module's destination	10
3. GSM requirements	10
4. Module's design	11
4.1. Topography	11
4.2. Resources	11
4.2.1. Binary inputs	12
4.2.2. Analog inputs	12
4.2.3. Binary outputs.....	12
4.2.4. Serial ports	13
4.2.5. Real time clock	13
4.3. Internal resources	14
4.3.1. Registers.....	14
4.3.2. Virtual registers.....	14
4.3.3. Clocks	14
4.3.4. Counters.....	14
4.3.5. Logger.....	15
4.3.6. MT2MT Buffer	15
4.3.7. Parameters	15
4.3.8. System variables.....	15
4.4. LED diodes.....	16
4.5. SET buttons	16
4.6. SIM card	17
4.7. Antenna.....	17
4.8. Power supply.....	18
4.9. Housing	18
5. Connections scheme	18
5.1. Binary inputs I1....I8	18
5.2. Binary inputs/outputs Q1....Q8	19
5.3. Analog inputs A1, A2.....	20
5.4. Communication ports.....	21
5.5. Power supply.....	23
6. Starting the module	24
6.1. Connecting antenna	24
6.2. First configuration.....	25
6.3. Inserting SIM card	26
6.4. Start up	26
7. Module's operating modes	27
7.1. MT Slave mode.....	28

7.2. Transparent mode.....	28
7.3. Modbus RTU Master mode	28
7.4. Modbus RTU Slave mode	29
7.5. Modem mode.....	30
7.6. Modbus RTU Mirror mode	30
7.7. Transparent PLUS mode.....	31
7.8. GazModem mode.....	31
7.9. M-Bus LEC mode	31
7.10. NMEA 0183 mode	32
7.11. FlexSerial mode	32
8. Configuration.....	33
8.1. General information.....	33
8.2. Parameter groups	33
8.2.1. Header.....	34
8.2.1.1. Module name	34
8.2.1.2. Module type	34
8.2.1.3. Module serial number	34
8.2.1.4. IMEI number.....	34
8.2.1.5. Internal program version.....	35
8.2.1.6. Configuration file version	35
8.2.1.7. Configuration identifier	35
8.2.1.8. Last configuration date.....	35
8.2.1.9. Last read of device time	35
8.2.2. General.....	35
8.2.2.1. Mode of operation	36
8.2.2.2. SIM card's PIN code.....	37
8.2.2.3. GSM band	37
8.2.2.4. Access to configuration	37
8.2.2.5. Configuration password	38
8.2.2.6. Configuration reading block	38
8.2.2.7. Reset after inactivity.....	38
8.2.2.8. Data overwriting protection	39
8.2.2.9. Password for data writing	39
8.2.2.10. Error display time	39
8.2.2.11. Use GPRS	39
8.2.2.12. Use SMS.....	40
8.2.2.13. Monthly SMS limit	40
8.2.2.14. Roaming.....	40
8.2.3. GPRS.....	41
8.2.3.1. APN name	41
8.2.3.2. APN user name	41
8.2.3.3. APN password	41
8.2.3.4. Device IP	41
8.2.3.5. IP assignment	41
8.2.3.6. Set IP.....	42
8.2.3.7. Virtual IP address.....	42
8.2.3.8. Number of GPRS transmission retries	42
8.2.3.9. Transmission timeout.....	43
8.2.3.10. Idle time.....	43
8.2.3.11. GPRS testing IP address.....	43
8.2.3.12. Number of login retries	44
8.2.3.13. Wait time after disconnection.....	44
8.2.3.14. Data frame format.....	44

8.2.3.15. Proxy server IP address	45
8.2.3.16. CRC compatibility	45
8.2.4. Authorized numbers.....	45
8.2.4.1. Number of phone numbers.....	45
8.2.4.2. Number of IP numbers	46
8.2.4.3. Phone	46
8.2.4.4. IP.....	46
8.2.5. Mode of operation	47
8.2.5.1. Transparent mode	47
8.2.5.1.1. GPRS transmission	47
8.2.5.1.1.1. Max. length of data packet	47
8.2.5.1.1.2. Data packet delimiter	47
8.2.5.1.1.3. Channel reservation time.....	48
8.2.5.1.1.4. Routing.....	48
8.2.5.1.1.5. Address offset	49
8.2.5.1.1.6. Broadcast address.....	49
8.2.5.1.1.7. Routing table size.....	49
8.2.5.1.2. Routing table	49
8.2.5.2. Modbus RTU Master mode	50
8.2.5.2.1. Routing table size	50
8.2.5.2.2. Routing table	50
8.2.5.3. Modbus RTU Slave mode	50
8.2.5.3.1. Routing table size	51
8.2.5.3.2. Routing table	51
8.2.5.4. Modbus RTU Mirror mode	51
8.2.5.4.1. Number of data blocks	51
8.2.5.4.2. Delay after error in communication with SLAVE	51
8.2.5.4.3. Data block 1...16.....	52
8.2.5.4.3.1. Modbus ID of Slave device.....	52
8.2.5.4.3.2. Space.....	52
8.2.5.4.3.3. Address of mapped space in module.....	52
8.2.5.4.3.4. Address of mapped space in SLAVE	53
8.2.5.4.3.5. Mapped space size.....	53
8.2.5.4.3.6. Mapped space read interval	53
8.2.5.5. Transparent PLUS mode.....	53
8.2.5.5.1. Max. length of data packet.....	54
8.2.5.5.2. Data packet delimiter	54
8.2.5.5.3. Channel reservation time	54
8.2.5.6. GazModem mode.....	55
8.2.5.6.1. Read interval.....	55
8.2.5.6.2. Number of retries	55
8.2.5.6.3. Transmission timeout	55
8.2.5.6.4. Threshold hysteresis.....	55
8.2.5.6.5. Alarm station IP address.....	56
8.2.5.6.6. Number of devices.....	56
8.2.5.6.7. MC 1...16.....	56
8.2.5.6.7.1. Address	56
8.2.5.6.7.2. Alarm reading	56
8.2.5.6.7.3. Signal reading.....	57
8.2.5.6.7.4. Current data reading.....	57
8.2.5.6.7.5. Current data block index.....	57
8.2.5.6.7.6. Current data block length	58
8.2.5.7. M-Bus LEC mode.....	58
8.2.5.7.1. Read interval.....	58
8.2.5.7.2. Number of retries	58
8.2.5.7.3. Transmission timeout	58
8.2.5.7.4. Threshold hysteresis.....	59
8.2.5.7.5. Gas meter address.....	59
8.2.5.7.6. Gas meter reading interval	59

8.2.5.7.7. Number of transmission retries to gas meter	59
8.2.5.7.8. Transmission timeout for gas meter.....	60
8.2.5.7.9. Number of devices.....	60
8.2.5.7.10. MC	60
8.2.5.7.10.1. Address 1....16	60
8.2.5.7.10.2. Geographical coordinates format	60
8.2.5.7.10.3. Identifier 1....16	61
8.2.5.8. NMEA 0183 mode	61
8.2.5.8.1. Data validity time.....	61
8.2.5.9. FlexSerial	61
8.2.5.9.1. Max. length of data packet.....	61
8.2.5.9.2. Data packet delimiter	61
8.2.6. Resources	62
8.2.6.1. Modbus ID number of module's internal resources.....	62
8.2.6.2. Terminals.....	62
8.2.6.2.1. Binary inputs I1,...I8.....	62
8.2.6.2.1.1. Name.....	62
8.2.6.2.1.2. Operating modes	62
8.2.6.2.1.2.1. Binary input.....	63
8.2.6.2.1.2.1.1. Filtering constant.....	63
8.2.6.2.1.2.2. Analogue inputs	63
8.2.6.2.1.2.2.1. Engineering units.....	64
8.2.6.2.1.2.2.2. Low reference - internal units	64
8.2.6.2.1.2.2.3. Low reference - engineering units.....	64
8.2.6.2.1.2.2.4. High reference - internal units	64
8.2.6.2.1.2.2.5. High reference - engineering units.....	64
8.2.6.2.1.2.2.6. Alarm HiHi	65
8.2.6.2.1.2.2.7. Alarm Hi.....	65
8.2.6.2.1.2.2.8. Alarm Lo	65
8.2.6.2.1.2.2.9. Alarm LoLo.....	65
8.2.6.2.1.2.2.10. Alarm hysteresis	65
8.2.6.2.1.2.2.11. Dead band	66
8.2.6.2.1.2.3. Counter inputs	66
8.2.6.2.1.2.3.1. Counting direction.....	66
8.2.6.2.1.2.3.2. Counting range	66
8.2.6.2.1.2.3.3. Activating slope	66
8.2.6.2.1.2.3.4. Filtering constant.....	67
8.2.6.2.2. Binary outputs Q1....Q8	67
8.2.6.2.2.1. Name.....	67
8.2.6.2.2.2. Operating modes	67
8.2.6.2.2.2.1. Binary input.....	68
8.2.6.2.2.2.2. Analogue inputs	68
8.2.6.2.2.2.2.1. Engineering units.....	69
8.2.6.2.2.2.2.2. Low reference - internal units	69
8.2.6.2.2.2.2.3. Low reference - engineering units.....	69
8.2.6.2.2.2.2.4. High reference - internal units	69
8.2.6.2.2.2.2.5. High reference - engineering units.....	69
8.2.6.2.2.2.2.6. Alarm HiHi	70
8.2.6.2.2.2.2.7. Alarm Hi.....	70
8.2.6.2.2.2.2.8. Alarm Lo	70
8.2.6.2.2.2.2.9. Alarm LoLo.....	70
8.2.6.2.2.2.2.10. Alarm hysteresis	70
8.2.6.2.2.2.2.11. Dead band	71
8.2.6.2.2.2.3. Counter inputs	71
8.2.6.2.2.2.3.1. Counting direction.....	71
8.2.6.2.2.2.3.2. Counting range	71
8.2.6.2.2.2.3.3. Activating slope	71
8.2.6.2.2.2.3.4. Filtering constant.....	72
8.2.6.2.2.2.4. Binary outputs.....	72

8.2.6.2.3. Analogue inputs AN1, AN2	72
8.2.6.2.3.1. Name.....	72
8.2.6.2.3.2. Filtering constant	72
8.2.6.2.3.3. Operating mode.....	73
8.2.6.2.3.4. Engineering units	73
8.2.6.2.3.5. Low reference - internal units.....	73
8.2.6.2.3.6. Low reference - engineering units	73
8.2.6.2.3.7. High reference - internal units	74
8.2.6.2.3.8. High reference - engineering units	74
8.2.6.2.3.9. Alarm HiHi	74
8.2.6.2.3.10. Alarm Hi	74
8.2.6.2.3.10.1. Alarm Lo	74
8.2.6.2.3.11. Alarm LoLo	75
8.2.6.2.3.12. Alarm hysteresis.....	75
8.2.6.2.3.13. Dead band.....	75
8.2.6.3. Serial port	75
8.2.6.3.1. Interface type	75
8.2.6.3.2. Transmission speed	76
8.2.6.3.3. Stop bits.....	76
8.2.6.3.4. Parity.....	76
8.2.6.4. Asynchronous clocks	76
8.2.6.4.1. Clocks TMR1, TMR2	77
8.2.6.4.1.1. Period.....	77
8.2.6.5. Synchronous clocks	77
8.2.6.5.1. Clock TMR3, TMR4.....	77
8.2.6.5.1.1. Start	77
8.2.6.5.1.2. Period.....	77
8.2.6.6. Logger	77
8.2.6.6.1. Active	77
8.2.6.6.2. Sampling interval	78
8.2.6.6.3. Buffer flush mode	78
8.2.6.6.4. Buffer flush interval.....	78
8.2.6.6.5. Recipient IP address.....	79
8.2.6.7. MT2MT Buffer	79
8.2.6.7.1. Active	79
8.2.6.7.2. Sending to PORT2	79
8.2.6.7.3. Buffer address.....	79
8.2.6.7.4. Buffer size	80
8.2.6.8. Constant parameters.....	80
8.2.6.8.1. Number of parameters	80
8.2.6.8.2. Parameter 1...128	80
8.2.7. Rules.....	80
8.2.7.1. SMS sending	80
8.2.7.1.1. Number of SMS sending rules	81
8.2.7.1.2. SMS sending rule	81
8.2.7.1.2.1. Trigger input.....	81
8.2.7.1.2.2. Trigger flag	82
8.2.7.1.2.3. SMS text	82
8.2.7.1.2.4. Recipient number	82
8.2.7.1.2.5. Sending additional information	82
8.2.7.2. Data sending.....	83
8.2.7.2.1. Number of data sending rules	83
8.2.7.2.1.1. Data sending rule	83
8.2.7.2.1.1.1. Trigger input.....	83
8.2.7.2.1.1.2. Trigger flag	84
8.2.7.2.1.1.3. IP address.....	84
8.2.7.2.1.1.4. Send	84
8.2.7.2.1.1.5. Buffer address.....	85
8.2.7.2.1.1.6. Buffer size.....	85

8.2.7.3. CLIP calls	85
8.2.7.3.1. Number of CLIP calls rules	86
8.2.7.3.2. Number of trials.....	86
8.2.7.3.3. Interval between trials.....	86
8.2.7.3.4. CLIP call rule.....	87
Each of rules residing on the list is defined by following parameters:	87
8.2.7.3.4.1. Trigger input.....	87
8.2.7.3.4.2. Trigger flag	87
8.2.7.3.4.3. Recipient number	87
8.2.7.3.4.4. Calling time	88
8.3. Configuration writing.....	88
8.4. Verification of configuration	88
9. Programming	88
9.1. General information.....	88
9.2. Starting to work	89
9.3. Main window layout	91
9.3.1. Menu items	91
9.3.1.1. File	91
9.3.1.2. Edit.....	93
9.3.1.3. Module	93
9.3.1.4. Help	97
9.3.1.5. Toolbar	98
9.4. Program editor table.....	98
9.5. Standard functions.....	98
9.6. Numeric keyboard.....	99
9.7. Auxiliary functions.....	100
9.8. Description of Program functions.....	100
9.9. Description of internal function blocks.....	109
9.9.1. Timers T1...T8.....	109
9.9.2. Counters C1...C8.....	110
9.10. Signal levels or edges	111
9.11. Filling and modifying program table.....	111
9.12. Downloading the program.....	112
9.13. Verifying the program.....	112
9.14. Examples of programs	112
9.14.1. The timer	112
9.14.2. The counter	113
9.14.3. Pulse generator	113
9.14.4. 2 pumps alternating action	114
9.14.5. 3 pumps toggle action.....	115
9.14.6. Checking bit's value in the registry.....	116
9.14.7. Alarm with confirmation	117
9.14.8. Motion detector	118
9.14.9. Logger program.....	118
10. Problem solving	119
10.1. LED signaling.....	119
10.1.1. Inputs/Outputs Q1...Q8.....	119
10.1.2. Inputs I1...I8	120
10.1.3. GSM status	120

10.1.4. GSM activity	121
10.1.5. GSM signal level	121
10.1.6. PORT 2 activity	122
10.1.7. Module's status.....	123
10.1.8. SET1, SET2 alarm thresholds	124
10.2. Unblocking of SIM card	124
10.3. Error signaling.....	125
10.3.1. Standard errors	126
10.3.2. Critical errors.....	127
11. Technical data.....	127
11.1. General.....	127
11.2. GSM/GPRS Modem	128
11.3. Power supply.....	128
11.4. Binary inputs I1...I8	129
11.5. Binary outputs Q1...Q8.....	129
11.6. Analog inputs A1, A2.....	129
11.7. Drawings and dimensions	130
12. Safety information	131
12.1. Working environment	131
12.2. Electronic equipment	131
12.2.1. Heart pacemakers	131
12.2.2. Hearing aids.....	132
12.2.3. Other medical equipment	132
12.2.4. RF Marked equipment.....	132
12.3. Explosive environment	132
13. Appendices	132
13.1. Data transmission in GSM systems	132
13.1.1. SMS.....	132
13.1.2. CSD (HSCSD)	132
13.1.3. GPRS.....	133
13.1.3.1. Advantages of GPRS technology.....	133
13.1.3.2. GPRS in telemetry applications	133
13.1.4. EDGE.....	134
13.1.5. UMTS	134
13.1.6. HSDPA	134
13.2. Application examples.....	134
13.2.1. Communication with single module	134
13.2.2. Point to point communication	135
13.2.2.1. Using internal resources.....	135
13.2.2.2. Data transmission from external devices.....	137
13.2.2.2.1. Configuration for transparent mode	137
13.2.2.2.2. Configuration for GazModem mode.....	137
13.2.2.2.3. Configuration for M-Bus Lec mode.....	138
13.2.2.2.4. Configuration for NMEA 0183 mode	138
13.3. Syntax for reading and writing data in SMS mode	139
13.4. Unlocking writing to internal registers.....	140
13.5. Working with dynamic IP addressing.....	141

13.6. Data formats.....	141
13.7. Module's Status format.....	142
13.8. Trigger inputs.....	143
13.9. Flags.....	143
13.10. RM-120.....	145
13.11. Memory map.....	146
13.11.1. Binary inputs space	146
13.11.2. Binary outputs space.....	149
13.11.3. Analogue inputs space	151
13.11.4. Internal Registers space	153
13.11.5. Auxiliary resources for GazModem mode.....	156
13.11.6. Auxiliary resources for M-Bus mode	158
13.11.7. Auxiliary resources of NMEA 0183 mode.....	163

1. Introduction

Despite the explosive expansion of mobile phone networks and the per definition digital nature of transmission utilized by them, these networks were not well-suited for the transfer of digital data streams until recently. The applied technologies used traditional modem protocols. This meant that the need to use circuit-switched mode for establishing connections and transmission capabilities was limited to point-to-point connections. Thus, we had to do with the typical analogue circuit-switched links technology used in traditional telephone systems adapted to the wireless digital transmission environment. A connection established for data transmission occupied the whole voice channel. As a result, simultaneous phone calls were impossible, and the cost of transmission depended on the connection time rather than the amount of the transferred data. In this situation, the real-time monitoring of units requiring constant supervision but generating a relatively small amount of data was not possible.

The situation changed radically after GSM operators introduced data transmission services in the GPRS (General Packet Radio Services) standard. The new technology, called the 2.5G standard - meaning Two and a Half Generation, is a bridge between the to-date technologies of the Second-Generation GSM networks (2G) and the Third-Generation technology (3G - UMTS) which has been waiting for application on a wide scale. However, broadband 3G technology is still very distant. So let us deal with the solutions available right now.

In providing this user's manual, we are aware that it will not answer all your questions and address all your doubts. This is why the manual will be regularly supplemented and modified. We ask for your comments and welcome suggestions in order to make this manual more useful.

INVENTIA Ltd.

2. Module's destination

MT-101 is a specialized telemetry module optimized for application in advanced measurement and alarm systems provided with a mains power supply.

General attributes of MT-101:

- Compact design
- Reach input/output set
- Local logging of measurement results
- Local execution of user program
- Ability to extend network with local extension modules
- Spontaneous transmission of data on occurrence of pre-defined alert states enabling application on objects requiring continuous monitoring.

A typical application field for MT-101 are all installations requiring local control and transmission of data to remote monitoring center.

We encourage getting acquainted with the modules' configuration and modes of operation along with examples of application in different configurations described in appendices.

3. GSM requirements

For proper operation, the module needs a SIM card supplied by a GSM operator providing GPRS and/or SMS services.

The GPRS/enabled SIM card has to be registered in the APN with static IP addressing. The unique IP address of the SIM card is an identification for the module within the APN. This enables module-to-module and module-to-server communication within the APN structure.

A good and strong GSM signal in the place where the module's antenna is located is imperative for the proper function of the module. Using the module in places where the signal is weak may lead to interruptions in transmission and possible loss of transmitted data along with increased costs generated by transmission retries

4. Module's design

4.1. Topography

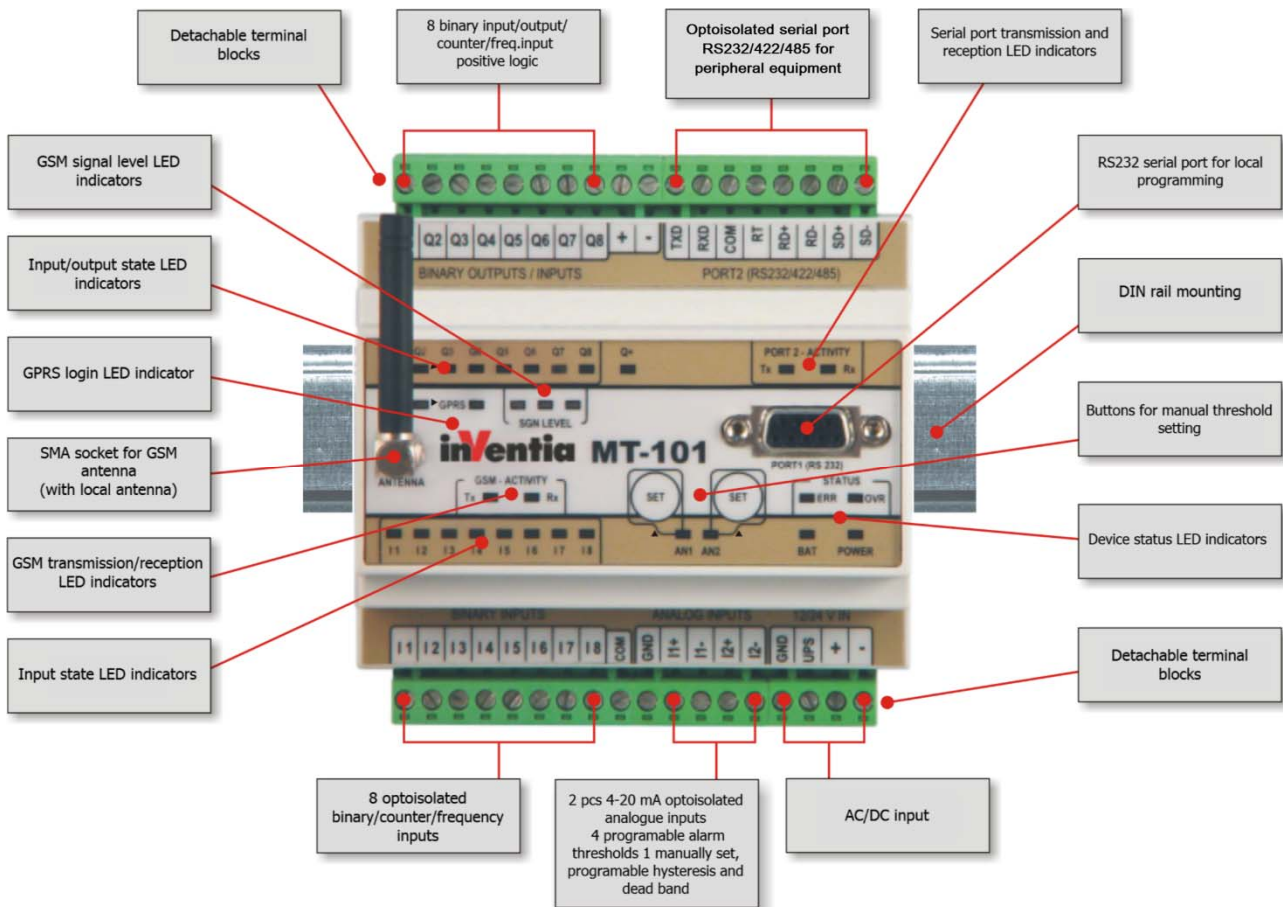

4.2. Resources

MT-101 module's resources

DI - binary inputs	8 (max.16)	working as: <ul style="list-style-type: none"> • binary input • counter input • analogue input F/U
DO - binary outputs	8	working as: <ul style="list-style-type: none"> • binary output • binary input • counter input • analogue input F/U
C - counters	0 (max.16)	each input and output can work as a counter input
AI - analogue inputs	2 (+ 16)	<ul style="list-style-type: none"> • 4 - 20 mA • as analogue F/U created of binary inputs and outputs
Serial PORT 1	1	standard RS232 - configuration and Modbus RTU Slave (ID1, 9600, hardware handshake [CTS/RTS])
Serial PORT 2	1	standard RS232/422/485 - different communication protocols

4.2.1. Binary inputs

The **MT-101** Telemetry Module is equipped with 8 dedicated binary inputs marked as **I1 – I8**. The inputs support both positive and negative logic.

Additionally, up to 8 binary inputs are available if binary outputs, **Q1 – Q8**, are configured to work in the binary input mode. For design-related reasons, those inputs work exclusively in positive logic.

The change of the input signal sets the alarm flag, connected with the corresponding binary input **I1 – I8**, **Q1 – Q8**, respectively as *Biln0->1*, *Biln1->0* i *Bi In Chg* . The flags may be used in rules processing.

Each of the binary inputs, **I1 – I8**, **Q1 – Q8**, may be configured independently also to work in the counter or analogue mode. The use of binary inputs in these additional modes will be presented further in respective sections of this manual.

4.2.2. Analog inputs

The **MT-101** Telemetry Module is equipped with two 420 mA analog inputs marked as **AN1** and **AN2**. The inputs are isolated both from each other and from the rest of the device, enabling the easy connectivity of the signal sources with different ground potentials. The AN1, AN2 analog inputs are the only inputs with manually-set alarm levels, set by SET buttons on the front panel of the device. This enables you to change the alarm level easily without the need to use the MTM configuration program.

Additionally, users may create up to 16 analog inputs by reconfiguring binary inputs **I1-I8** and binary outputs **Q1-Q8** to work in quasi/analog mode. After reconfiguration, all inputs work in input signal frequency-to-analog conversion, so for proper operation, one has to connect analog signal source via analog-to-frequency converter which outputs a square wave of frequency proportional to analog signal. Input signal conversion range is **0-2kHz**.

During configuration of analogue inputs, the user can set engineering units and precisely rescale the input signal. The alarm levels and the time of input signal integration are also configurable. The possibility to configure as much as four - and in the case of the **AN1** and **AN2** inputs five - alarm levels guarantees supervision flexibility of monitoring of analogue signals.

Both alarms triggered by the analogue signal value (4) and the rate of signal change (2) are available. As mentioned above, it is possible to define additional alarm levels for **AN1** and **AN2** inputs manually by using buttons on the device front panel.

Additional information about manually/set threshold levels for A1 and A2 are described in chapter SET buttons.

Analogue inputs have two parameters defined. They are Hysteresis and Dead band. The value of hysteresis defines insensitivity of device for signal variations near threshold values preventing excessive generation of events. The range of hysteresis allows generating event only when the signal on the input changes by defined value. Hysteresis is set for all selected analogue input alarm thresholds.

FLags *AnLoLo*, *AnLo*, *AnHi*, *AnHiHi*, *An DB*, *An Set Fall*, *An Set Rise*, set by analogue signal changes may be employed for rules processing.

4.2.3. Binary outputs

MT-101 Telemetry module is equipped with 8 dedicated binary outputs marked **Q1....Q8**. The state of outputs is set by writing desired value into a binary outputs memory register.

This record may be performed either remotely via GPRS or locally as the execution of a user-defined program.

For each binary output, the state of forcing signal is compared with actual output state signal. Upon detection of discrepancy, the *BiOutErr* Flag is raised and may be used for rules processing.

As stated before for Binary inputs, any binary output may be individually configured to work either as binary input, counter input or quasi-analogue input. That makes the hardware universal in application.

4.2.4. Serial ports

MT-101 Telemetry Module is equipped with two serial ports **PORT1** and **PORT2**.

PORT1 works only in **RS232** mode and is used for local configuration of parameters. In order to perform local configuration, connect this port to a PC-class computer with running MTM program. Operating parameters of this port are not modifiable and the length of the connecting cable should not exceed 3 m. **This port is not isolated!**

PORT1 can also be used as Modbus RTU Slave port without need of changing modules configuration. Module's Modbus ID on this port is always 1 (options in configuration applies only to **PORT2**). Transmission parameters are:

- speed of 9600bps,
- 8 data bits,
- no parity,
- 1 stop bit,
- hardware handshake (RTS/CTS).

This port is ideal for connecting external graphical or text panel supporting Modbus RTU Master.

NOTICE!

The first configuration has to be performed locally, via PORT1 in order to provide the module with basic GPRS communication parameters like PIN code and APN name.

PORT2 is capable of operating in **RS232/422/485** modes and serves communication with external data sources. The interface and operating mode is selected during module's configuration. This port is optoisolated.

4.2.5. Real time clock

MT-101 Module is equipped with **astronomical time clock (RTC)**.

The clock is a base for defining working cycles of module, timers and time stamps for measurement results recorded in registers. Imprecise clock setting results in faulty time stamping and subsequent loss of vital information. For that reason, it is recommended to set the clock to UTC time instead of the local time zone of the module's placement.

CAUTION!

The module's RTC clock does not automatically adjust to summer/winter time. To avoid loss of data during manual time adjustment, UTC time is recommended .

CAUTION!
The RTC clock is powered from an internal battery, and as long as it is operational there is no need to reset the time after power-off. Since the clock precision is not absolute, periodical time adjustment may be necessary.

Setting the time is described in configuring mode documentation for the **MTM** program.

4.3. Internal resources

4.3.1. Registers

MT-101 Telemetry module has in its internal resources 16 bit input registers and 16 bit internal registers. Remote access to these areas is possible using standard Modbus commands.

Internal Registers are not reset at power off.
Input Registers are reset at power on.

Module's 16 bit registers store unsigned values in range 0-65535. In order to increase the range of stored values, pairs of 16 bit registers were reserved to create 32 bit registers storing signed values for use in user/defined internal program.

4.3.2. Virtual registers

MT-101 Telemetry module feature 16 bit Virtual Registers. They reflect input (VREG_BIx) and output (VREG_BOx) bit spaces. Using virtual registers gives easy access to bit groups and copying data between bit spaces and registers. Access to registers is possible through module's internal program using standard programming functions described in the chapter Programming.

4.3.3. Clocks

MT-101 Telemetry Module is equipped with 4 programmatic clocks divided in two groups with different functionalities.

2 programmable **Asynchronous clocks** TMR1, TMR2, enable cyclical time measuring for up to 100 days (8 640 000 s) and 2 programmable **Synchronous clocks** TMR3, TMR4, enable cyclical time measuring from 1 min to 24 h with synchronization with module's RTC clock.

Properly configured clock counts the time setting after each completed period, for one program cycle, a flag in binary inputs space (respective *TMR1*, *TMR2*, *TMR3*, *TMR4*). These flags can be used in internal controlling program or for triggering transmission on event.

4.3.4. Counters

Each of **MT-101** module's inputs/outputs is capable of counting pulses and storing the value in 32 bit counter with capacity of 2 147 483 647 (31 bits + counting direction bit) events. The counter can count „up“ or „down“, and the range can be freely defined in range of 1 to 2 147 483 647.

Counting "up" means that the counter value is increased by 1 for each detected pulse and after reaching the value set as "counter length-1" is reset to "0". Counting "down" diminishes the counter value by 1 for each detected pulse and after reaching the value set as "counter length-1" is reset to "0" to resume the value of defined maximum.

Crossing the value of counter length sets *Counter* alarm flag for respective input. The flag can be used in the internal controlling program or for triggering transmission on event.

4.3.5. Logger

MT-101 Telemetry Module is equipped with internal **Recorder**, storing state changes on binary inputs/outputs and on analogue inputs. The Recorder has a volume of 140 data records. New records are written to memory after change of state on binary inputs/outputs or at crossing of dead band defined for analogue inputs. Records are stamped with time stamp from module's internal real time clock (RTC). It is recommended to set module's RTC compliant to UTC for preserving data integrity.

Data written in the recorder is transmitted accordingly to configured options to defined IP address. Confirmation of reception removes records from the recorder.

NOTICE!
The recorder function is available only in GPRS mode.

4.3.6. MT2MT Buffer

MT2MT buffer enables creation of system where MT-101/102/202 modules may exchange information (Internal Registers) with each other without any relaying instance.

Data transmission from one module to another goes like this:

1. In sending module the event/triggered sending of the buffer has to be defined.
2. In receiving module switch the **MT2MT** buffer on and define it's placement and size so that it encompasses the area of sent registers.
3. Upon reception of event-triggered data frame, registers from event-reporting module are copied into receiving module's registers and MT2MT_x bit informing about modification of MT2MT buffer with data from respective IP is set. (Bit number reflects the index of IP address in GPRS/Authorized numbers in configuration). MT2MT_x bits are set for 1 program cycle immediately after reception and recording it in MT2MT buffer.
4. Data transmission in this system copies registers of sending module into the exact same register in receiving module. When designing communication between larger number of modules, separate register areas have to be sent and appropriately large areas define for **MT2MT receiving buffer** in receiving modules.

4.3.7. Parameters

In **MT-101** module max. 128 constant parameters that are loaded into module's memory during initialization of the module can be defined.

These constants are stored in 16 bit registers and have numerical values ranging from 0 – 65535.

Constant parameters may be used for parameterization of user programs.

Defined parameters are preserved after power loss or module reset.

4.3.8. System variables

MT-101 has system variables connected to GSM/GPRS connection state and power supply. Variables state is reflected by flags that can be used as transmission triggers or in internal control programs.

FS1_ups = 1 - loss of potential at module's UPS pin

FS1_q+ = 1 - loss of power supply for binary outputs Q1..Q8

FS1_gprs = 1 - informs upon log off from GPRS network

Full list of system variables is placed in Memory map chapter in Appendices.

4.4. LED diodes

LED indicators placed on **MT-101** front panel are convenient during module start up phase.

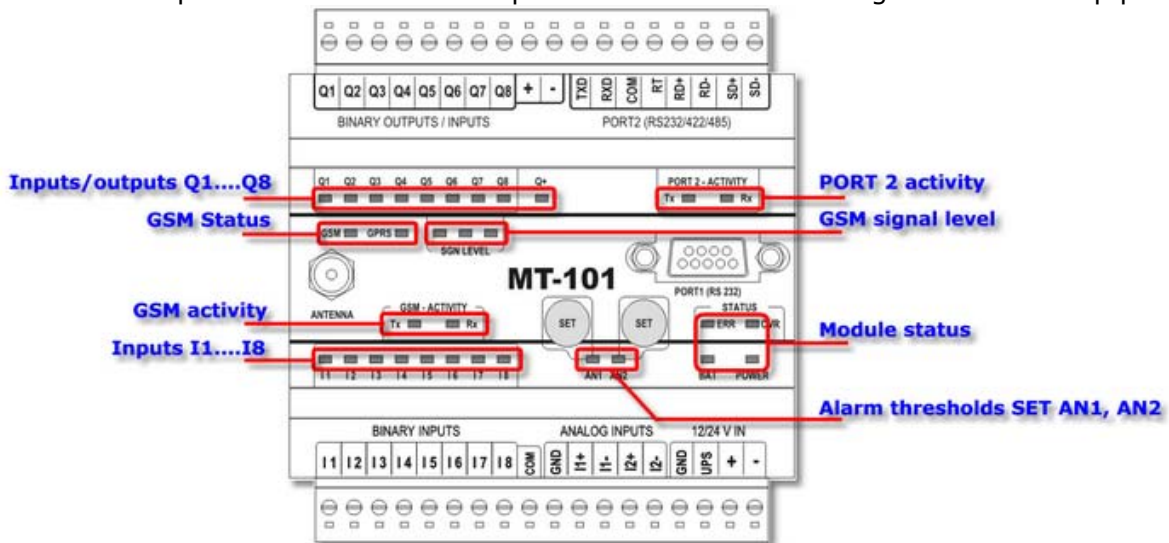

Detailed description of signaling patterns is placed in chapter LED signaling.

4.5. SET buttons

SET buttons placed on **MT-101** front panel are for manual setting of auxiliary alarm thresholds for analogue inputs A1 and A2.

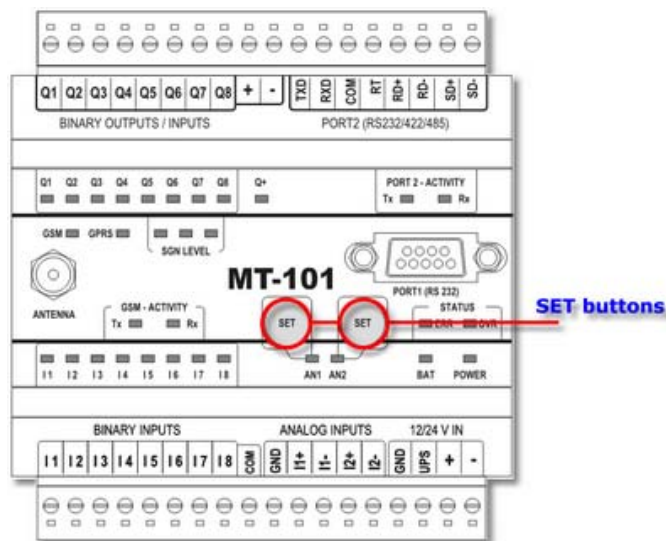

Manually set thresholds can not be modified or read during configuration of module. There are two flags connected to these thresholds, [ANX_Set_F](#) and [ANX_Set_R](#), informing about crossing of the set level, and two alarms - [An Set Fall](#) and [An Set Rise](#) that may be used for rule processing.

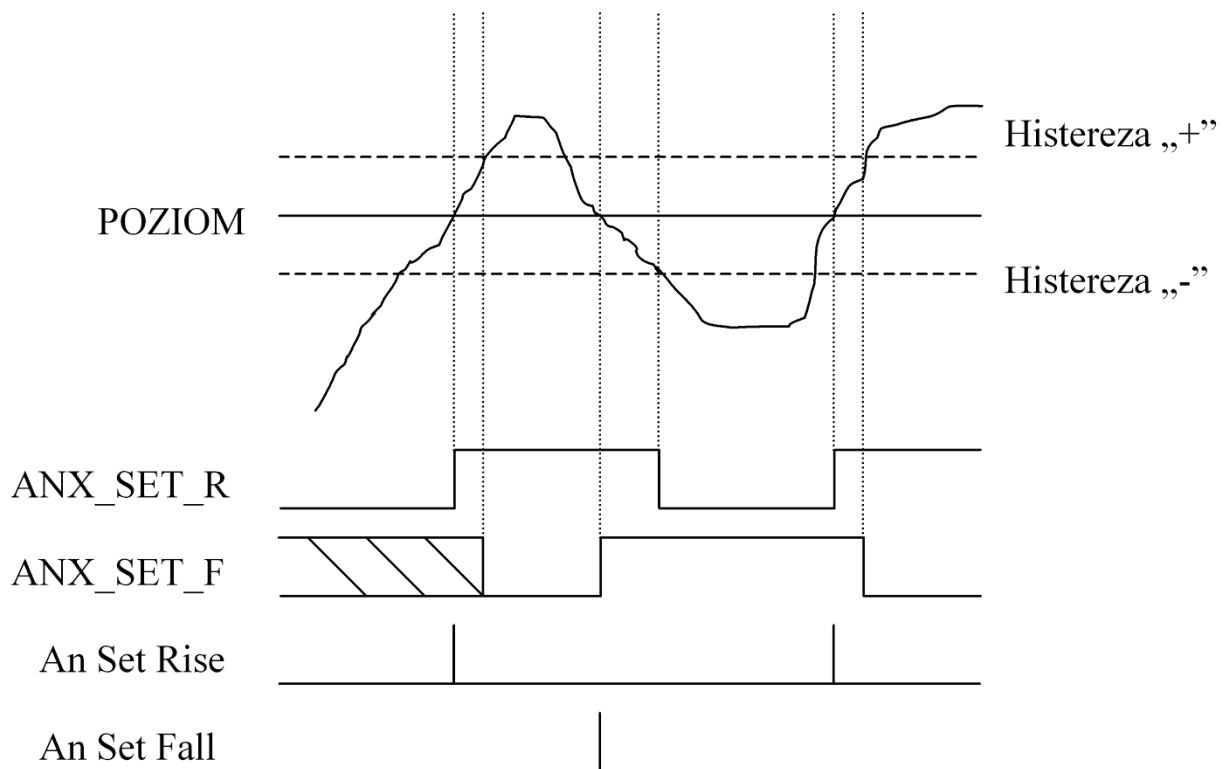

As shown by graph, the value at which flags *ANX_Set_F* and *ANX_Set_R*, are set and cleared depends not only on input signal level but on hysteresis defined for given input. Proper value of hysteresis protects against excessive alarm generation by noise or oscillation around threshold value signal.

4.6. SIM card

MT-101 telemetry module is equipped with standard miniature SIM card holder for connecting card to GSM modem.

If use of GPRS transmission is intended the SIM card should have GPRS option and possibility of login to APN for assigning static IP addresses activated. In absence of static IP address, use of the module for GPRS transmission is impaired.

Proper placement of the SIM card is imperative for module's operation. The module accepts only SIM cards operating in low potential technology 3,3V.

4.7. Antenna

Attachment of antenna is essential for proper operation of MT-101 telemetry module. SMA socket is placed on module's front panel. The attached antenna has to secure appropriate radio signal level enabling login to GSM network.

The type and placement of antenna has significant influence on module's sender/receiver circuits. GSM signal level is reflected by **SGN LEVEL LEDs** on module's front panel . When GSM signal level is not sufficient for reliable operation LED is not lit. In that case the use of a directional antenna should be considered.

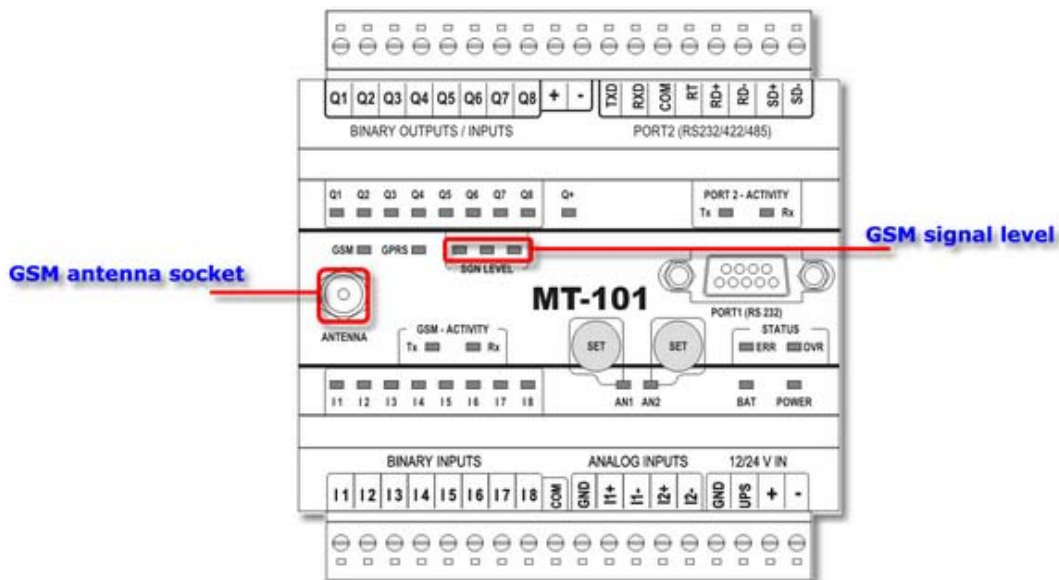

4.8. Power supply

MT-101 may be powered by 18...26,4 V (AC) or 10,8...36 V (DC).

NOTICE!
Exceeding the range of power supply may cause faulty operation or damage the module!

The module may work with auxiliary battery supply securing operation for some time after main supply failure. In order to discriminate whether the module is powered from battery or from main supply the module has a binary input marked **UPS**, where the signal informing that main supply has failed. Main supply voltage drop below 10,8 V raises the *FS1_ups* system flag. The flag may be used for rules processing. The input may be used to signal main supply failure and switch over to battery supply.

4.9. Housing

MT-101 module is encapsulated in standard housing made of plastic compliant with safety requirements and protecting the module in standard operating environment. The applied solution complies with standard industrial requirements for DIN rail mounting.

5. Connections scheme

This chapter shows standard configurations of connections securing proper operation of **MT-101** module's integral inputs in all available operating modes.

5.1. Binary inputs I1...I8

Integral binary inputs marked as **I1...I8** may work in both positive and negative logic making circuit design very easy.

Binary inputs **I1...I8** – in positive logic:

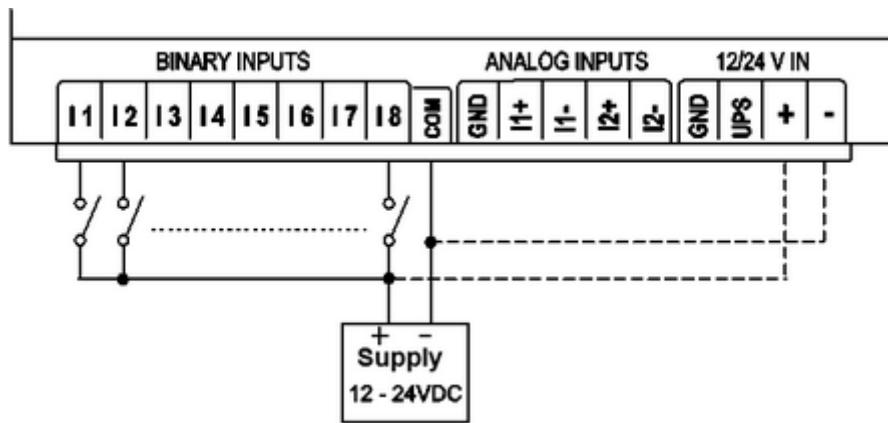

Binary inputs **I1....I8** – in negative logic:

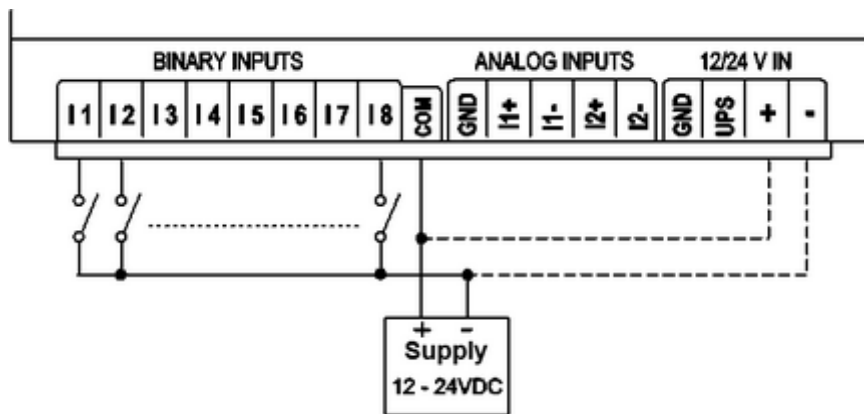

Each of binary inputs **I1....I8** may operate as a counter input or analogue input with frequency conversion to analogue value. The change of input operating mode is done during configuration.

Typical connection for counting input is identical to standard input connection for both negative and positive logic. The only difference lays in counting of pulses appearing on the input and storing the result in a 32 bit register assigned to this input.

Binary input operating in analogue mode has slightly different connection. It is assumed that the signal is a square wave with variable frequency in range 0....2kHz, where momentary frequency corresponds to measured analogue value. The wave usually comes from a converter exchanging measured analogue value to proportional frequency in defined range.

5.2. Binary inputs/outputs **Q1....Q8**

Integral outputs **Q1....Q8** may operate, depending on selected mode as inputs or outputs, In both cases only positive logic applies.

Binary outputs **Q1....Q8** – in positive logic:

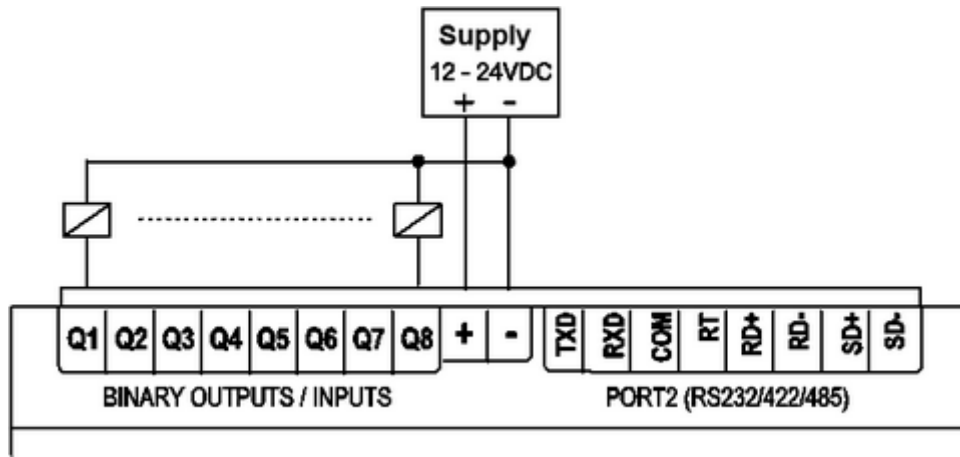

Binary inputs **Q1**....**Q8** – in negative logic:

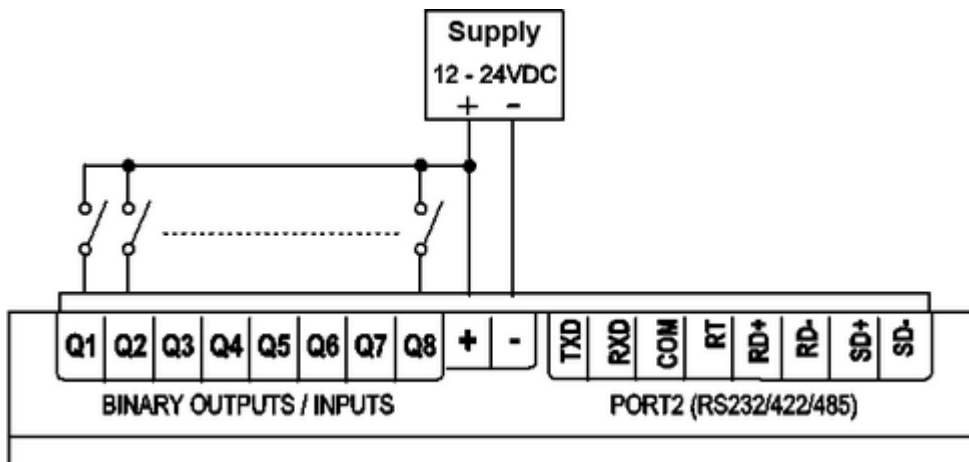

Any of binary outputs **Q1**....**Q8** may operate as counter input or analogue input with frequency conversion to analogue value. The change of input's operating mode is done during configuration.

Typical connection for counting input is identical to standard input connection for positive logic. The only difference lays in counting of pulses appearing on the input and storing the result in a 32 bit register assigned to this input.

Binary input operating in analogue mode has a slightly different connection. It is assumed that the signal is a square wave with variable frequency in range 0....2kHz, where momentary frequency corresponds to measured analogue value. The wave comes usually from a converter that exchanges measured analogue value to proportional frequency in defined range.

5.3. Analog inputs **A1**, **A2**

Integral analogue inputs **A1**, **A2** cooperate with active as well as passive converters (sensors)

Analogue inputs **A1**, **A2** – connection with active output converter

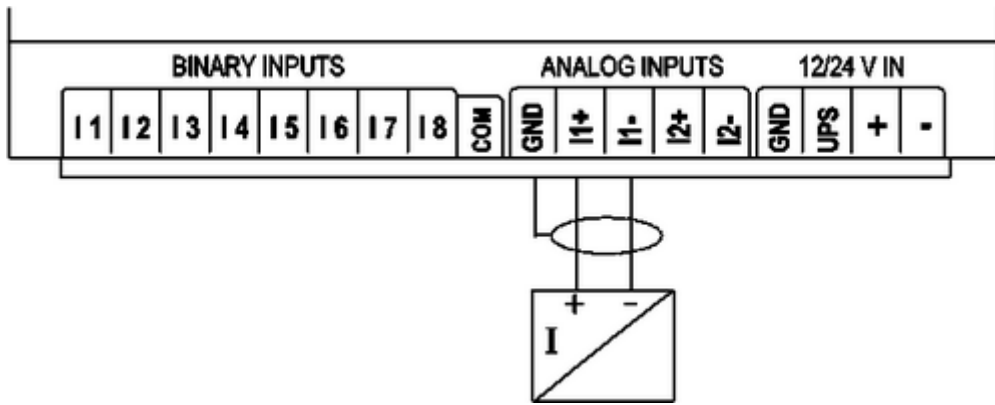

Analogue inputs **A1**, **A2** – connection with passive output converter

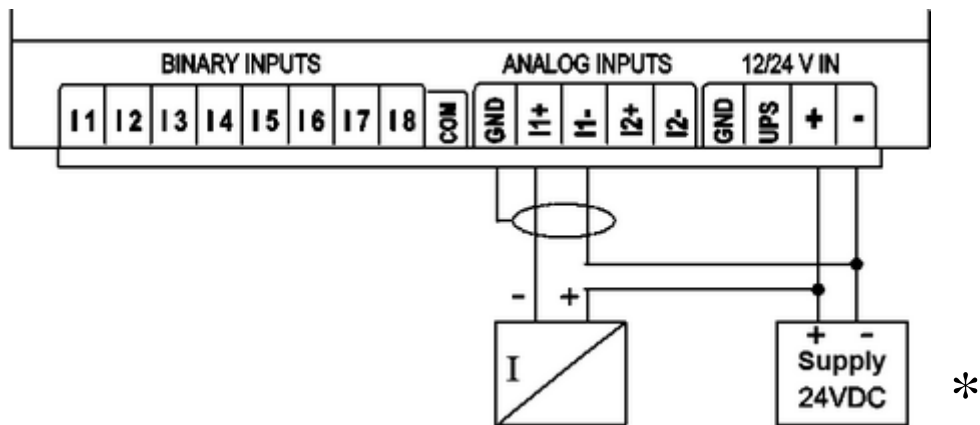

* in noisy environment, use independent supply for input-output circuits is recommended.

5.4. Communication ports

Telemetry module is equipped with 2 communication ports for different applications. They are :

PORT 1 (RS232 – configuration, Modbus RTU Slave [ID1])

- The not optically-isolated Port is used for configuration
- Connection point to point to PC via RS-232

DB-9 connector (female)

Pin	description
1 -	
2 - TXD	transmitter output
3 - RXD	receiver input
4 -	
5 - GND	ground
6 -	
7 - CTS	handshake input
8 - RTS	handshake output
9 -	

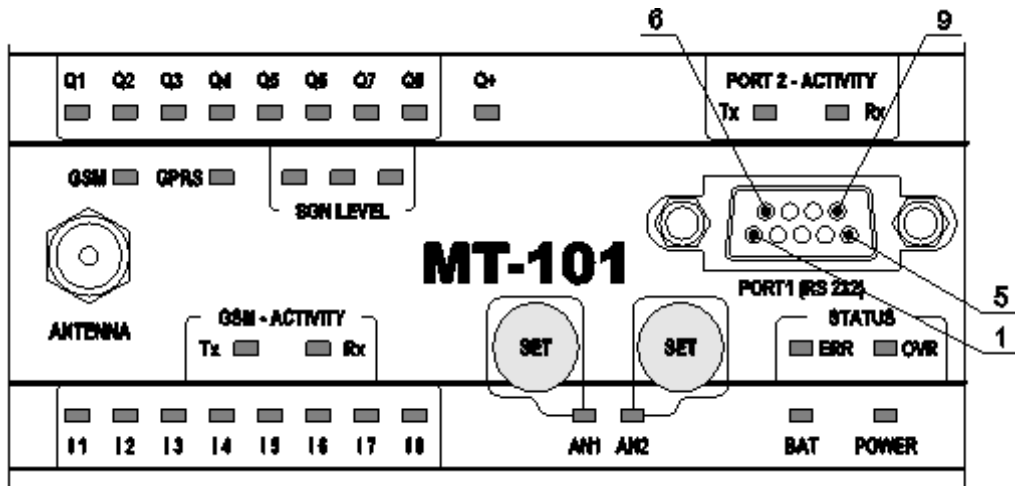

PORT 2 (RS232/422/485 – communication)

- The Port is optically-isolated, used for data exchange.
- Maximal isolating voltage 60Vrms.
- Operating mode selected by configuration application.

Description

pin	Description
TXD	transmitter output
RXD	receiver input
COM	interface common ground (GND)
RT	terminator – if necessary connect to RD+
RD+, RD-	for RS485 (transmitter, receiver), for RS422 (receiver)
SD+, SD-	for RS422 (transmitter)

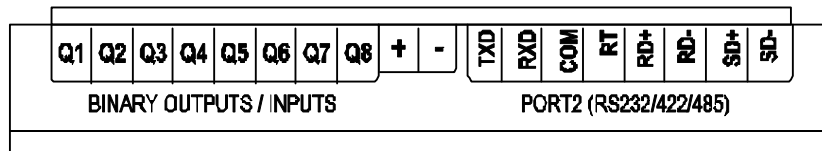

For RS232 mode the length of the cable should not exceed 15 m.

NOTICE!

- Supply cables length < 10 m
- Signal cables length < 30 m
- For longer cables it is recommended to use external overvoltage protection.

5.5. Power supply

The power supply is connected to „+“ and „-“ terminals (preserving polarisation only when supplying direct current).

Pin	Description
GND	Module's ground *
UPS	Input – power supply state signaling. Active state for voltage > 10,8V When not employed , shortcut with +.
+	Positive pole of power supply**
-	Negative pole of power supply**

* - Not recommended in standard appliances since it may increase emitted noise.
** - For AC supply polarisation does not apply.

Example:

Connection diagram with battery backup

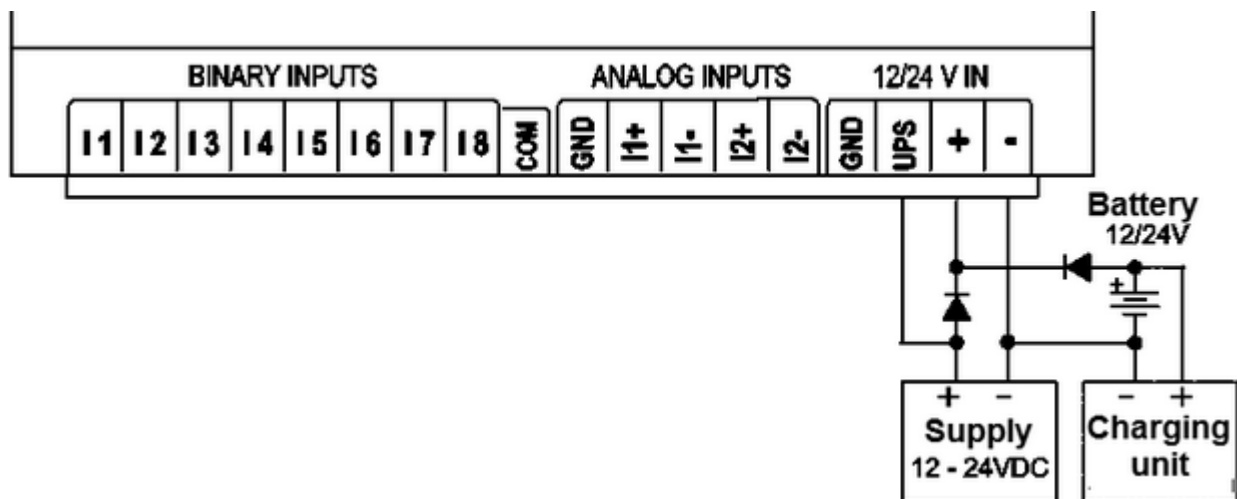

NOTICE!

Due to MT-101 module's high momentary current consumption the supply must be capable of delivering $\geq 2A$ current.

Improper power supply may result in faulty operation and damage the module!

6. Starting the module

Starting **MT-101** module requires few basic activities.

Recommended sequence:

1. GSM antenna attachment.

NOTICE!
The antenna has to be attached at every power up since it is a necessary transmitter load.
The module exchanges information with available GSM networks in order to test availability of performing emergency calls (112) even without SIM card

2. Configuration of basic operating parameters
3. Insertion of SIM card
4. Restart of the module

6.1. Connecting antenna

Connecting external GSM antenna is an essential condition for proper module operation. The type of antenna depends on the desired mounting type and power of GSM signal in antenna placement area. As previously mentioned, the antenna has to be attached at every power up because it is a necessary transmitter load and absence endangers the module's transmitter part. Even with no SIM inserted, the module exchanges information with available GSM networks in order to secure possibility of sending emergency calls (112). The antenna is connected to **MT-101** module via SMA connector placed on the front panel of device.

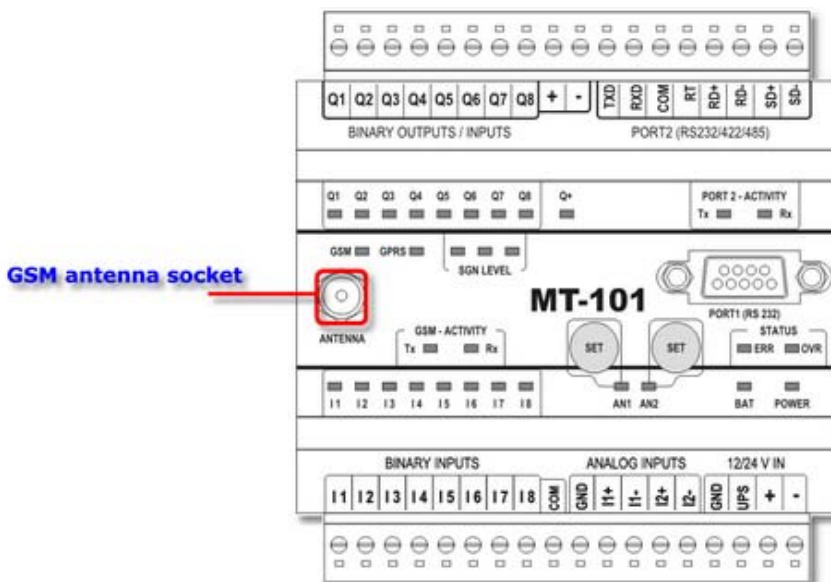

The choice of antenna type depends on GSM signal propagation at place where the module is installed. In most cases, a standard small size antenna is sufficient. Where GSM signal is weak using multi-segment directional antenna may be necessary.

6.2. First configuration

First configuration of **MT-101** is necessary for setting up basic parameters making logging to GSM network possible and, optionally, servicing GPRS.

NOTICE!
Since a new module or a module configured for other circumstances may not have necessary data for proper login to GSM network, it is necessary to perform the first configuration in local mode by serial RS232 cable connected to Port 1

To configure the module, connect it via RS232 cable to a computer running **MTManager**. Comprehensive information about installation, use and attachment of **MTM** program to configured modules can be found in **MTM User Manual**.

Logging into GSM/GPRS network requires basic information about the SIM card in use and optionally about the APN that the module is going to operate within when GPRS mode is turned on.

The parameters are:

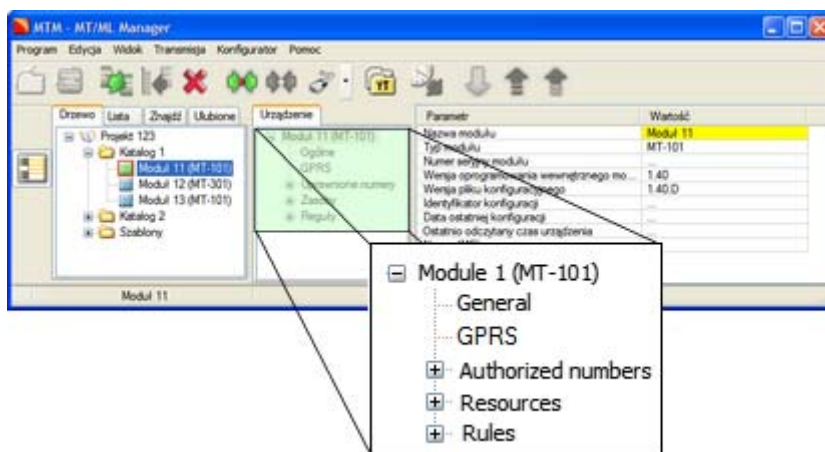

In **General** group:

PIN code for SIM card

insert PIN code of the SIM card intended for the module, unless the card is configured not to ask for PIN code.

Use GPRS

Yes - if SMS and GPRS packet transmission is intended

No - if the module is to work in SMS mode only.

In **GPRS** group - visible if *Use of GPRS* is set to **Yes**:

APN Name

insert name of APN, in which GPRS transmission is to take place.

APN User Name

insert user name (if required by Network Operator)

APN login password

insert password (if required by Network Operator)

NOTICE!
Upon each writing of new configuration into MT-101, the module performs full RESET

These parameters are all that is needed to be able to log in GSM/GPRS network. One has to remember that modules with basic configuration can not send any information. Therefore, after verifying that module logs in to GPRS network, one has to perform full configuration of module parameters enabling all full intended functionality of the module.

6.3. Inserting SIM card

One of the fundamental conditions for proper operation of the module is inserting a **SIM** card enabling module to send SMS and/or packet data in GPRS network.

The best way to do it is when the power supply disconnected. Theoretically the SIM card may be inserted into the module before the first configuration is performed, but note that two attempts of entering wrong PIN code the cause module to stop attempting to log into network. Should this happen, the module has to be unlocked.

NOTICE!
Earlier models of MT-101 do not have the function preventing triple attempt of inserting wrong PIN code resulting permanent locking of access to SIM card and subsequent permanent locking of module. Should this happen, the SIM card has to be unlocked using the PUK code. The details of the procedure unlock the card is described in chapter Problem solving

Insert **SIM** card in cradle and slide it into the slot as depicted below until the gentle click is heard.

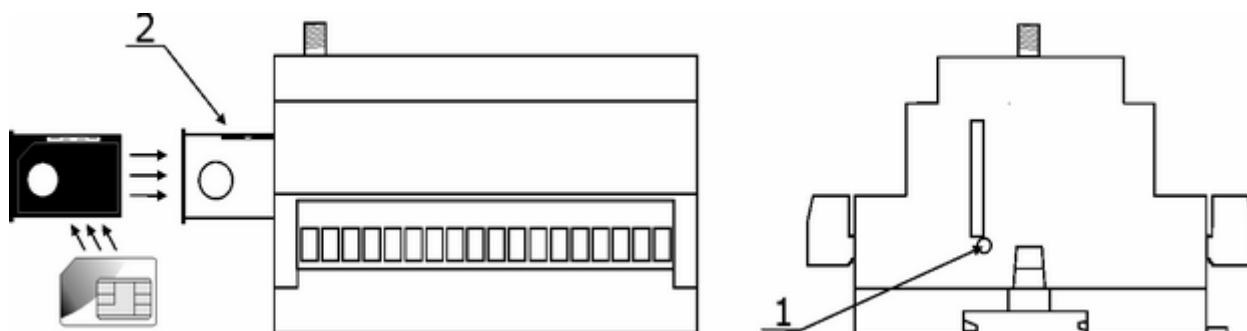

Properly inserted **SIM** cards secure reliable connection with module's terminals.

6.4. Start up

After performing the first configuration and inserting SIM card, proceed to start up. Switch the power supply off and on again to reset the module.

NOTICE!
If the SIM card was inserted to the module during first configuration resetting the module is unnecessary as every writing of new configuration forces RESET of the module.

Well/configured MT-101 module logs into GPRS network within 20 -30 seconds. The login sequence is displayed by diagnostic LEDs at the front panel of the module. Explanation of sequence is described in details in LED signaling chapter.

In case of difficulties when logging into GPRS, verify configured parameters and pay attention to LEDs indicating GSM signal level.

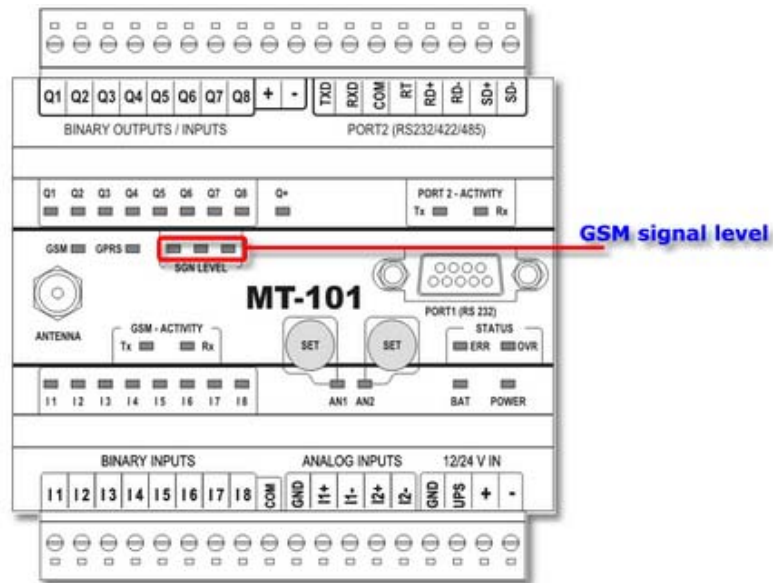

To weak GSM signal may render log-in impossible.

7. Module's operating modes

Following chapters describe particular operating modes of **MT-101** module. Full benefit of module's features depends on knowledge of different modes functionalities. Therefore we encourage to study this section with great attention.

The module operates in following modes:

- **MT Slave Mode** - default Mode, allows only remote reading of module's internal resources
- **Transparent mode** - enables efficient transmission of data frames sent by unknown serial protocols
- **Modbus RTU Master Mode** - turns module into router of Modbus RTU packets
- **Modbus RTU Slave Mode** - enables local and remote access to module's internal and external resources and to internal resources of connected to PORT2 other Slave devices employing same transmission protocol.
- **Modem Mode** - enables (in justified cases) abandoning all functionality of MT-101 and using it as a plain, but automatically logging into selected network GSM/GPRS modem.
- **Modbus RTU Mirror Mode** - adds to Modbus RTU Slave mode a very sophisticated functionality enabling using the module as local Master of Modbus RTU protocol. The module is mapping registers of external Modbus devices into it's own internal registers. This functionality significantly reduces GPRS transmission necessary for efficient control.
- **Transparent PLUS Mode** - extends standard Transparent Mode with ability of using module's internal resources.
- **GazModem Mode** - enables local control of devices working in GazModem protocol - not available in present version of module's firmware.
- **M-Bus LEC Mode** - enables local control of devices of LEC type (heat consumption meters) and other devices with identical mapping of data holding registers -not available in present version of module's firmware.
- **NMEA 0831 Mode** - prepared to read information subset transmitted to PORT2 by devices operating within NMEA 0831 standard.
- **FlexSerial Mode** - prepared to adopt other transmission protocols by employing user defined internal program.

7.1. MT Slave mode

MT Slave is the basic and default operating mode of MT-101 module. In this mode, the module makes all internal resources accessible and visible under Modbus ID defined in configuration. PORT2 is not serviced.

Mode is employed where there is no need for communication with external devices via PORT2. In other words, only module's own resources are used.

In this mode, data transmission to central system-master as well as communication among modules operating in same mode is enabled.

7.2. Transparent mode

In this mode, the module receives data at serial PORT2, buffers it in memory and converts to packets to send to defined recipients.

This mode allows data transmission without recognition of the protocol the data is sent in. Data received at PORT2 is transmitted to all IP addresses defined in Authorized IP numbers group when working in broadcast mode.

In order to reduce or eliminate transmitted data redundancy, two options are available:

- packet routing - useful for unambiguous definition of where in transmitted frames the recipient address is placed and how it is recorded without knowing the foreign protocol. In that case, routing table can be created to eliminate redundant transmissions.
- transmission channel reservation - diminishes transmitted data volume provided that multiple queries of one device are executed not knowing the foreign protocol. When channel reservation is employed only the first query is sent to all modules defined in Authorized IP numbers list. After reception of the response the module reserves, for a defined time, the direct communication channel with the module that responded to the last query thus creating a temporary point to point connection. The reservation time is counted since reception of last GPRS packet. Consecutive packets received from that module prolong channel reservation while sending packets does not prolong the reservation. When channel reservation time is set to 0 [sec], the module does not reserve channel and works in standard mode receiving and sending packets from all defined remote units.

7.3. Modbus RTU Master mode

In this mode, the module cooperates with the device acting as MODBUS RTU MASTER.

The master sends queries addressed to Slave devices to module's PORT2 .

Upon reception of the frame at PORT2, the module verifies recipient device address. Since module's own resources are available in Modbus RTU Master mode under Modbus ID assigned to module, the instruction is carried out and replay sent to PORT2 (to the master) when matched with address.

Frames with other Modbus ID addresses transmitted via GPRS are routed to other recipients on the basis of a table assigning IP addresses to Modbus IDs (routing table - redirection). In other words, MT-101 acts as a router of packets sent from Master to remote Slave units. This mode enables creation of data acquisition system, where standard queries generated by PLC controller or any other device working in Modbus RTU Master mode. This solution is not recommended if master role is played by a PC running Windows 2000 or newer and collected data is used by applications capable of using data collected by OPC or written in CSV or SQL format.

Following rules apply for Modbus RTU Master mode:

- Frames are sent only to recipients having Modbus ID matching address received via PORT2.
- All frames received at PORT2 are sent to recipients having Modbus ID=0 written in the table.
- Frames with address 0 (broadcast frames) are set to all recipients declared in the routing table.
- Repeating IP address in the table does not cause multiple transmission to the same recipient. This makes sending frames with different Modbus IDs to same IP recipient possible, connecting a large number of devices with various Modbus IDs to PORT2 of the remote module operating in MODBUS RTU Slave mode.
- The frame will be dispatched to recipient only when IP address is defined in Authorized numbers list of GPRS section and sending option is checked.
- After receiving frame via GPRS, the module checks if it is addressed to its internal resources (address matches declared Modbus ID). If that is the case, the instruction is carried out and confirmation sent to sender. This behaviour enables creation of Multi-master systems securing proper data transmission and access to all resources of the system.
- If Modbus ID of received frame does not match module's ID, the frame is forwarded to PORT2 and may be received by the Master device.

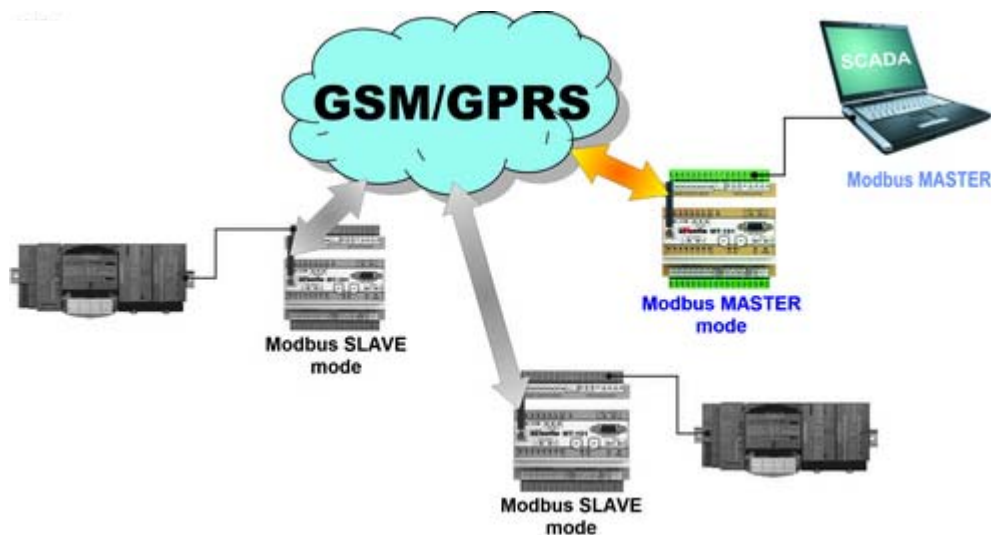

7.4. Modbus RTU Slave mode

In this mode, the module acts as a network node serving both own resources and all connected to PORT2 devices operating in Modbus RTU Slave mode, waiting for GPRS data frames.

Upon reception of the frame, it investigates recipient's address (matching declared Modbus ID with its own).

If the address matches, the instruction is carried out and confirmation set to sender. If it does not match the frame is forwarded to PORT2. The module waits for 0,5 sec for reply. When reply comes or the time elapses, the module whether new data frame arrived via GPRS.

Sending frames not addressed to module's ID to PORT2 is unconditional as module does not have the list of connected to PORT2 Slave devices.

Replies are sent to sender as standard. Sending of replies to additional Master units can be defined in routing table.

The IP address of additional Master is stated in the second column of the table, and the device Modbus ID from which replies have to be sent to additional master are stated in third column.

If third column states "0", replies from all slaves will be sent to corresponding IP address.

This means that it is possible to send replies to any number of devices acting as protocol Master. (Multimaster mode).

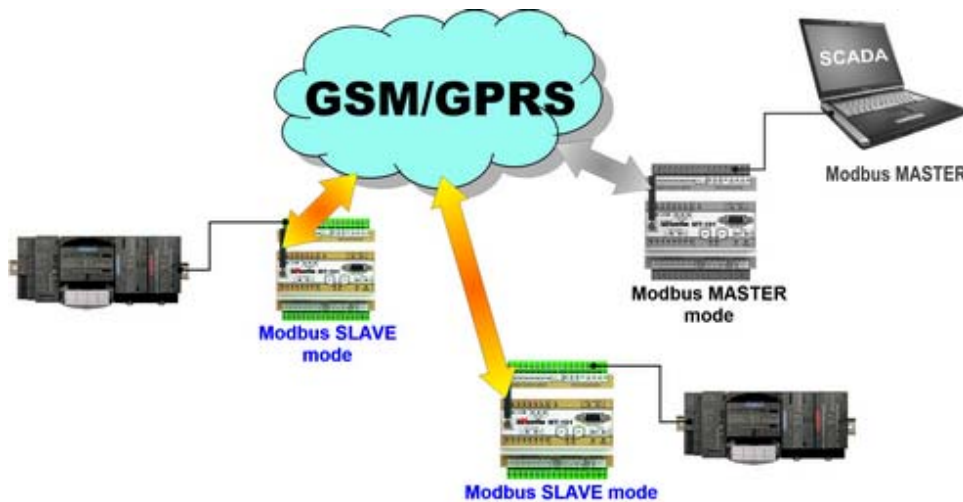

7.5. Modem mode

In this mode, the module establishes communication channel between PORT2 and internal GSM modem input. The channel is available after entering PIN code and logging on to the network, relieving the user of modem initiation.

In order to control the transmission, AT commands issuing is necessary. Full control of modem's operation is carried out by external device connected to PORT2 of the module.

This mode does not require configuration of any parameter beyond right PIN code but in turn does not give access to any MT-101 features except transmission control.

Being able to use transmission control, modem may be reset if no activity is detected in defined time. It prevents the phenomenon of an irrevocably "hanging modem" which in case of remote deployment is usually expensive.

7.6. Modbus RTU Mirror mode

Modbus RTU Mirror mode is an extension of MODBUS RTU Slave mode. Seen from GPRS side the module acts exactly as it does in Modbus RTU Slave mode securing remote access to own resources as well as resources of any slave connected to PORT2. The addition feature provides the possibility of resource mapping of devices connected to PORT2 into internal module Registers. With this option active, the module cyclically reads mapped areas of external devices and refreshes internal Registers.

Writing to external devices is possible as well. In Mirror mode, for every internal program cycle (100 ms) the module compares state of mapped areas and upon detection of change in any Register, a frame writing the change to external device is generated. Values in internal registers may be changed remotely by master system or locally by internal (user defined) program.

Highlights of Modbus RTU Mirror mode:

- The ability to remotely read resources of different areas and devices by one Modbus frame (reading internal Registers of the module), thus increasing efficiency of GPRS transmission.
- The ability to generate alarms on state change in remote devices. Local data reading in conjunction with processing of data by internal program and function of generating events significantly increases potential and dynamics of the whole system, simultaneously reducing costs of transmission compared to systems based on cyclic querying from master
- The ability of local control of the object including extension devices.

Bear in mind that:

- In communication with Slave devices, the module employs standard MODBUS RTU frames, with functions 1, 2, 3, 4 for reading, functions 5, 6 do for writing singular changes and functions 15 and 16 for block writing.
- Upon power up or start of communication with peripheral equipment, the module synchronizes Mirrored space with with Slave's contents, updating its registers with Slave contents. This assures that writing values to Mirrored space during interrupted communication with the slave will not overwrite slave's values upon reestablishment of communication. Bits informing about state of communication with slaves (SL1_ok .. SL16_ok) corresponding to defined during configuration areas, reside in transmission in binary inputs space. High corresponding bit signals good communication with particular slave.
- In Modbus RTU Mirror mode Slaves mirrored in module can not transmit events. When servicing events from slaves is required, standard Modbus RTU Slave mode is recommended.

7.7. Transparent PLUS mode

Transparent PLUS mode is an extension of standard Transparent mode enabling access to internal resources of the module using standard Modbus frames. The Module inspects every frame received via GPRS analyzing syntax and CRC. Upon detection of Modbus RTU frame addressed to the module (matching ID), the frame is not sent to PORT2. The module carries out the instruction and sends confirmation to the sender only, regardless of number of addresses defined in GPRS section.

The function of channel reservation is independent of access frames. Reception of access frame does not reserve the channel. Access to the module from another master during channel reservation is possible.

Bear in mind that:

- In this mode the module may exchange GPRS data correctly with modules operating in Modbus Master mode, Modbus Slave, Modbus Mirror if the CRC option is set to Yes in Modbus modes.
- During analysis of received frames, the highest priority is assigned to access frames (frames with the structure compliant with Modbus frame). Such frames will not be sent to serial port.
- The access to internal resources from serial port is not possible.

7.8. GazModem mode

GazModem mode is an extension of Modbus RTU Slave mode with functionality similar to that available in Modbus Mirror mode with mapping of register space of peripheral Slave into MT-101 internal registers.

This mode was implemented due to requirement of reading from devices operating in Gaz-Modem and Gaz-Modem2 protocols created by Plum Sp. z o.o. for use in different volumetric gas counters and other gas systems. The user employing telemetry modules is capable of reading current data, binary inputs and alarm signals from gas devices.

7.9. M-Bus LEC mode

M-Bus LEC mode is an extension of Modbus RTU Slave mode with functionality similar to that available in Modbus Mirror mode with mapping of register space of periferal Slave into MT-101 internal registers.

This mode was implemented due to requirement of reading from devices operating in M-Bus protocol, applied mainly for measuring of energy consumption in heating systems.

Since MT-101 module has no capability of direct communication with M-Bus units it is necessary to connect an external converter to PORT2. The converter RM-120 is one of our products.

7.10. NMEA 0183 mode

NMEA 0183 mode is an extension of Modbus RTU Slave mode with the function of receiving and interpreting of data in NMEA 0183 format sent by peripheral device attached to PORT2.

Standard NMEA 0183 protocol frames are decoded and stored in module's internal registers where they are ready for further processing.

This mode was implemented to serve the AIRMAR weather station, but may be used to communicate with GPS receivers using NMEA 0183 protocol for data exchange.

7.11. FlexSerial mode

In **FlexSerial** mode, the transmission at PORT 2 is serviced exclusively by a user program resident in the module. Only standard access to module's resources is possible via GPRS. No option of sending data frame to PORT 2 while data incoming to PORT2 arrives exclusively to internal program is available.

Buffer structure

PORT 2 in the program is served by 2 buffers and helps registers placed in holding register's memory space. Transmission and reception are independent on each other. The buffers have a length of 512, 16 bit registers, where only low order bytes are used for transmission. In other words, one 16 bit register stores 1 byte on low order byte. High order byte remains unused.

Data reception

Configuration for FlexSerial mode uses 2 variables that define the way data stream received at PORT 2 is converted into data packets available for internal program.

Received data is stored in registers. Registers P2RCV_B1...P2RCV_B512, build the receiving buffer. Register P2RCV_NO controls data reception.

Data received at PORT 2 is internally buffered in 6kB buffer and put into receiving buffer only when register P2RCV_NO has "0" value. During data insertion to the buffer the length of inserted package is recorded into P2RCV_NO register. The user program should process data from receiving buffer after detecting a non zero value in P2RCV_NO buffer and when done should set P2RCV_NO to 0 value, thereby initiating loading of next package to buffer. Received data is always placed at the beginning of the buffer so the first byte of the package is placed in P2RCV_B1 register.

Furthermore, in binary output space there is P2RCV_err bit that is set high when reception error occurs. F.e.: receiving buffer overflow, parity, stop bit error. P2RCV_err bit is not automatically reset so in order to be useful for diagnostic purposes, it has to be reset by the user program. The state of this bit does not have influence on data reception algorithm and is only used for received data diagnostic.

Resources

Name	Space (address DEC)	Description
P2RCV_NO	Internal registers (1022)	Register controlling reception
P2RCV_B1...513	Internal registers. (1024...1535)	Receiving buffer
P2RCV_err	Output bits (60)	Reception error signaling

Data transmission

Registers P2SND_B1...P2SND_B512 constitute sending buffer, while register P2SND_NO controls the transmission. Writing a non zero value to P2SND_NO triggers transmission of data packet with length equal to the value written into P2SND_NO from sending buffer. Data is transmitted from the beginning of the buffer, so the first Byte of the packet is taken from P2SND_B1 register.

After emptying the buffer, the register P2SND_NO is automatically zeroed thus informing that the next packet may be prepared for sending. Register P2SND_Bx may be modified only when P2SND_NO is zeroed.

If transmission error occurs (for example during transmission to P2SND_NO the value higher than 512 was written), P2SND_err bit in binary outputs space is set high.

Bit P2SND_err is not zeroed automatically so in order to use it in diagnostic purposes it must be zeroed by user's program.

Resources

Name	Space (address DEC)	Description
P2SND_NO	int. Registers (1023)	Register controlling sending
P2SND_B1...513	int. Registers (1536...2047)	Sending buffer
P2SND_err	Output bits (61)	Sending error signaling

8. Configuration

8.1. General information

The configuration of MT-101 module, as is the case for other modules in the MT series, is carried out using the MTM (MT Manager) program portal, delivered free of charge to users of our telemetry solutions.

The portal is a specialized environment providing full control of the entire telemetry system regardless of the system's size. The possibility of dividing hardware resources into Projects and Folders facilitates efficient management of very complex telemetry systems.

After adding a new module to the environment and selecting it, all module parameters are available for editing. Detailed description of functions and their applications are to be found in MTM user manual.

NOTICE!
Availability of different functions and parameters depends on module's firmware version and the settings of parameters they may be dependent on.

8.2. Parameter groups

For clarity and ease of use, the operating parameters of MT-101 module are divided into logically or functionally connected groups in the following order:

Header group - contains unmodifiable parameters describing the module, its firmware and configuration.

General group - contains basic parameters defining module's operating mode

GPRS group - contains necessary parameters to log in to GPRS network and defines parameters vital for transmission reliability.

Authorized numbers group - contains lists of phone numbers and IP addresses of other terminals authorized for communication with configured module.

Operating mode group - contains parameters necessary for configuring currently selected operating mode.

Resources group - defines parameters for hardware and software resources related to reading and processing measurement data.

Rules group - contains lists of transmission tasks to be carried out upon occurrence of activating criteria

8.2.1. Header

Header of parameter structure describes **MT-101** telemetry module. It holds basic information unique to the module, the configuration contained by module and configuration file version. Information displayed is not user editable and solely used for verification and information purpose.

8.2.1.1. Module name

Function	- displays name assigned to module during configuration
Data type	- text
Range	- n/a, read-only parameter
Comments	- n/a

8.2.1.2. Module type

Function	- displays the type of configured telemetry module
Data type	- text
Range	- n/a, read-only parameter
Comments	- n/a

8.2.1.3. Module serial number

Function	- displays serial number configured telemetry module
Data type	- text
Range	- n/a, Read-only parameter
Comments	- this field displays module serial number assigned during manufacturing. This number is static and unique identifier of the unit.

8.2.1.4. IMEI number

Function	- displays GSM modem's IMEI number
Data type	- text
Range	- n/a, read-only parameter
Comments	- n/a

8.2.1.5. Internal program version

Function	- displays the identification of actual version of internal telemetry module program (firmware)
Data type	- text
Range	- n/a, read-only parameter
Comments	- the value of this field changes automatically after download of firmware

8.2.1.6. Configuration file version

Function	- displays version identification of configuration file used for actual configuration
Data type	- text
Range	- n/a, Read-only parameter
Comments	- value depends on module's firmware version. Auxiliary extension character defines the sub-version

8.2.1.7. Configuration identifier

Function	- displays identification of current configuration
Data type	- hexadecimal
Range	- n/a, read-only parameter
Comments	- the value of this parameter increases automatically by 1 after each successfully stored configuration.

8.2.1.8. Last configuration date

Function	- displays time and date of last successful configuration change
Data type	- text
Range	- n/a, read-only parameter
Comments	- the value changes automatically with successful configuration change. Useful in tracing unauthorized configuration changes.

8.2.1.9. Last read of device time

Function	- displays internal module time recorded during last configuration reading or during last time setting
Data type	- text
Range	- compliant with Date and Time format
Comments	- this field is useful in verifying last access time and checking internal module clock settings (RTC)

8.2.2. General

General group encompasses parameters vital for whole module. Contains data necessary for successful login to GSM network and parameters defining module operating mode.

Note: values set here have impact on module's behavior and in worst case, when chosen improperly may even lock the module.

NOTICE!
**Availability of parameters described in following chapters depends on
firmware version and the superior parameters they depend on.**

8.2.2.1. Mode of operation

Function	- defines module mode of operation in terms of internal functions and serviced protocols. The selection controls access to parameters connected with selected operating mode
Data type	- selection list
Range	- <i>MT Slave</i> module's default setting. In this mode, module answers GPRS queries addressed to its Modbus ID and sends SMS and data according to defined Rules but does not relay queries to PORT2. <i>Transparent</i> mode allowing sending GPRS data to PORT2. <i>Modbus RTU Master</i> in this mode, the MT-101 module cooperates with external unit acting as System Modbus Master connected to PORT2. The module routing table assigns Slaves' Modbus IDs to IP addresses of their respective GPRS serving nodes in order to optimize transmission. <i>Modbus RTU Slave</i> in this mode, the internal module resources are treated as resources of the slave with Modbus ID defined during configuration. Frames received by the module carrying its Modbus ID are serviced locally while frames carrying other Modbus IDs are sent to PORT2. <i>Modem</i> in this mode, the module acts as GPRS modem controlled by AT commands. At power on, the module uses PIN code defined during configuration and logs on to GSM network. <i>Modbus RTU Mirror</i> mode enables remote querying of module resources along with attached units working in Modbus RTU protocol and event-triggered data sending, as well as creating a mirror copy of connected units in module's internal registers. <i>Transparent PLUS</i> identical with <i>Transparent</i> , extended with ability of querying internal resources and event processing. <i>GazModem</i> mode enables cooperation with units connected to PORT2, using GazModem protocol. MT-101 acts as a local Master enabling local reading of connected units and alarm processing. This mode minimizes transmission required to supervise units. The mode is not supported by standard firmware and requires firmware marked as MT-101_x.xxgm.bin. <i>M-Bus LEC</i> this mode is dedicated to cooperation with units employing M-Bus protocol. As in the GazModem mode, the MT module acts as local master for units connected to PORT2, enabling readings from central heating nodes. The mode is not

supported by standard firmware and requires firmware marked as MT-101_x.xxgm.bin.

NMEA 0831

this mode is dedicated to NMEA 0831 protocol. Received data is stored in module's internal registers compliant to established standards.

FlexSerial

this mode enables integration of any kind of PLC controllers, I/O units, measurement equipment, operator panels equipped with serial communication port RS-232/422/485 on the base of programmed servicing of non standard protocols.

- Default value** - *MT Slave*
- Comments** - choosing the appropriate working mode is essential for exploiting all available features. The choice influences availability of configuration parameters thus optimizing module operation.

8.2.2.2. SIM card's PIN code

- Function** - defines PIN access code for SIM module delivered by GSM operator. For SIM modules not protected by PIN code, the value is insignificant.
- Data type** - text
- Range** - letters and numerals, max 8 characters
- Default value** - 0000
- Comments** - wrong pin can cause locking of SIM module

CAUTION!
Caution is vital when setting the PIN code value . Entering faulty PIN code may cause module start-up to be impossible and lock SIM card. In latest versions of the module, attempting to enter wrong PIN code twice renders a third attempt impossible.

8.2.2.3. GSM band

- Function** - sets the frequency of locally-employed GSM system.
- Data type** - selection list
- Range** - *EU-900/1800 MHz*
for areas employing 900/1800 MHz standard
US-850/1900 MHz
for areas employing 850/1900 MHz standard
- Default value** - *EU-900/1800 MHz*
- Comments** - Parameter active only in modules using quad-band Wavecom WISMO Quick PLUS modem module. Setting US-850/1900 MHz band in other modules does not have any effect

8.2.2.4. Access to configuration

- Function** - defines configuration access restrictions. The user can decide whether access to configuration will be allowed for all or only

	selected IP addresses.
Data type	- selection list
Range	- <i>All</i> Unrestricted access for any IP address within the APN <i>List</i> Access limited to addresses defined in the list of <i>Authorized numbers, IP</i> for addresses with <i>Configuration</i> option set to <i>Allowed</i> .
Default value	- <i>All</i>
Comments	- Note that access restriction configuration applies only to GPRS connection and when used improperly may block remote access for users that should have the right to configure the module.

8.2.2.5. Configuration password

Function	- defines the password protecting access to configuration of the module. The password will be required for both local and remote access, thus protecting against unauthorized configuration alterations. The password does not protect against reading current configuration or the module status.
Data type	- text string
Range	- letters and numerals, max. 32 characters
Default value	- n/a
Comments	- since the only way of unlocking the module is resetting it to factory settings, it is vital that the password is stored in a safe way and available when needed.

8.2.2.6. Configuration reading block

Function	- blocks reading of module configuration even when using valid password
Data type	- selection list
Range	- <i>Yes</i> Reading of configuration from the module is impossible. <i>No</i> Module is not protected against reading of configuration
Default value	- <i>No</i>
Comments	- This parameter does not influence writing a new full configuration but prevents writing changes if configuration identifiers in the module and in MTM application do not match

8.2.2.7. Reset after inactivity

Function	- Defines (in minutes) the interval between data reception by modem. Initiates modem restart when exceeded.
Data type	- number
Range	- 0...10080 [min]
Default value	- 60 [min]
Comments	- This parameter is valid only for Modem mode. Value 0 disables this function. The value of this parameter should not be lower than master system query interval. Setting of lower value results in frequent

resets of the modem.

8.2.2.8. Data overwriting protection

Function	- blocks writing of data into internal module registers, protecting data significant to proper operation of module.
Data type	- selection list
Range	- <i>Yes</i> Data writing is possible when password is provided <i>No</i> Data writing to internal registers not protected.
Default value	- <i>No</i>
Comments	- This parameter protects the module against accidental or intended intrusion into internal resources without preventing users authorized by password to make changes.

8.2.2.9. Password for data writing

Function	- defines password for Data overwriting protection parameter
Data type	- text field
Range	- letters and numerals, max. 32 characters
Default value	- n/a
Comments	- when Data overwriting protection parameter is active, writing to module is possible only after providing valid password. The procedure to be followed in this case is to be found in chapter Appendices - Unblocking writing to internal registers

8.2.2.10. Error display time

Function	- Defines (in seconds) error display time on Status GSM and SGN LEVEL and on ERR LED groups
Data type	- number
Range	- 1...60 [s]
Default value	- 30 [s]
Comments	- setting of too small value makes error code identification difficult while too long value extends the restart time after error code display

8.2.2.11. Use GPRS

Function	- defines means of communication for the module
Data type	- selection list
Range	- <i>Yes</i> The Module works in GPRS mode. Upon power-up module tries to log in to selected APN. This mode requires SIM cards with enabled GPRS access. <i>No</i> The Module works in GSM mode. The only way of remote communication is SMS messaging. In this mode, pre-paid type SIM cards with no GPRS work without problems.
Default value	- <i>Yes</i>
Comments	- n/a

8.2.2.12. Use SMS

Function	- defines working sub-mode of module operating in GPRS
Data type	- selection list
Range	- <i>Yes</i> Module operating in GPRS mode has SMS services active. As a result, the GPRS session is suspended every 12 min. and the module checks for incoming text messages. Event triggered SMS transmission is instantaneous. <i>No</i> Module operates in GPRS mode and SMS services are inactive.
Default value	- <i>Yes</i>
Comments	- This parameter is available only in GPRS mode . Setting this parameter to <i>No</i> may result in filling the SIM card with received messages that are not processed by internal logic.

8.2.2.13. Monthly SMS limit

Function	- Defines maximum amount of SMS messages module may send during 1 month in order to prevent uncontrolled number of sent messages thus saving on running expenses. Setting the parameter to <i>0</i> removes the limit.
Data type	- number
Range	- 0 ... 65.535
Default value	- 0
Comments	- This parameter is available in no GPRS and in GPRS mode with <i>Yes</i> option for use SMS chosen.

CAUTION!
Reaching the limit set by this parameter results in unconditional (without warning) stop of SMS sending. Note that no SMS will be sent until the month is up even in alarm situations!

8.2.2.14. Roaming

Function	- defines whether roaming in foreign GSM network is allowed
Data type	- selection list
Range	- <i>On</i> in case of absence of home network, the module will attempt to login to available operator network. <i>Off</i> login to foreign networks is not allowed
Default value	- <i>Off</i>
Comments	- This parameter decides whether the Module will try to login to available foreign network in the absence of home network. This is possible only when the SIM card in module has roaming service enabled.

8.2.3. GPRS

GPRS Group encompasses parameters connected to login and data transmission in GPRS system. Parameters defined within this group are mandatory and optional as well as convenient for transmission optimization.

8.2.3.1. APN name

Function	- defines APN name selected for GPRS transmission
Data type	- text
Range	- letters, numerals, special characters - max. 32 characters
Default value	- empty
Comments	- absence of APN name disables login to GPRS network

8.2.3.2. APN user name

Function	- defines APN user name
Data type	- text
Range	- letters, numerals, special characters - max. 32 characters
Default value	- empty
Comments	- Optional parameter used only if required by GSM network operator

8.2.3.3. APN password

Function	- defines password for APN user account
Data type	- text
Range	- letters, numerals, special characters - max. 32 characters
Default value	- empty
Comments	- Optional parameter used only if required by GSM network operator

8.2.3.4. Device IP

Function	- allows user to define IP number for newly created module definition and displays IP number read from the module configuration that was assigned to the module during last login to GPRS network
Data type	- IP number field
Range	- 0.0.0.0 - 255.255.255.255
Default value	- 0.0.0.0
Comments	- if the number is not read in nor written manually after local configuration, remote configuration of the module via GPRS will not be possible.

8.2.3.5. IP assignment

Function	- selects IP address assignment mode during login to GPRS network procedure
Data type	- selection list

Range	- <i>DHCP</i> IP address is assigned by GSM network according to operator policy. It may be static or dynamic address.
	<i>Manual</i> IP address is assigned by GSM network to the value set in Set IP field by user. This mode is applicable only when operator policy allows forcing IP address by the user.
Default value	- <i>DHCP</i>
Comments	- <i>Manual</i> mode is allowed only in few GSM networks

8.2.3.6. Set IP

Function	- enables manual entering of IP when parameter IP assignment is set to <i>Manual</i>
Data type	- IP number field
Range	- 0.0.0.0 - 255.255.255.255
Default value	- 0.0.0.0
Comments	- forcing of IP address mode assigned by operator is serviced only in few GSM networks

8.2.3.7. Virtual IP address

Function	- defines IP address that will be placed in internal data header of frames sent by the module.
Data type	- IP number field
Range	- 0.0.0.0 - 255.255.255.255
Default value	- 0.0.0.0
Comments	- Parameter mandatory in case of operating MT-101 module in GSM networks where operator uses dynamic address translation of internal addresses to static external addresses visible to external users. The parameter enables placing the external IP address under which the internal network node is visible in the header for sent data frame. As a result, external recipients will experience match of sender's IP with IP address written in data header. It is necessary due to double authentication of received data employed by MT-Data Provider (MT-DP).

8.2.3.8. Number of GPRS transmission retries

Function	- defines number of retries of GPRS transmission in case of not receiving confirmation in time defined by Transmission timeout parameter
Data type	- number
Range	- 0...255 Setting this parameter to 0 results in sending data without waiting for confirmation of error-free reception.
Default value	- 3
Comments	- In normal conditions, it is not recommended to set this value to higher than 3. This effectively secures against loss of transmitted data without hampering processing following rules. Note that consecutive data will be sent after successful conclusion of current transmission.

8.2.3.9. Transmission timeout

Function	- Defines waiting time (in seconds) for confirmation of reception of sent data frame.
Data type	- number
Range	- 0...655 [s]
Default value	- 12 [s]
Comments	<p>- This value in connection with declared Number of GPRS transmission retries defines max. time of one data packet transmission, described by formula:</p> $\text{MaxT} = (\text{number of GPRS transmission retries} + 1) * \text{transmission Timeout}$ <p>For default values: $\text{MaxT} = (3 + 1) * 12 = 48\text{s}$. Please notice that calculated value does not define the time of delivery but the time to elapse before the module considers that transmission to appointed IP address is not possible (the data will be lost due to unavailability of recipient) and moves to sending next data frame awaiting transmission.</p>

8.2.3.10. Idle time

Function	- Defines the interval (in seconds) for sending data frame (ping) controlling the ability to communicate with the network in case of transmission inactivity
Data type	- number
Range	- 0...86400 [s] (24h)
Default value	- 240 [s]
Comments	<p>- in case of inactivity longer than the value defined in this parameter the module sends a control frame in order to check whether transmission is still possible. During network check, control data frame is sent to module's own IP address, respecting timeout and number of retries parameters. The length of the frame is 45B+length of the module's name. The frame is sent to module's own IP address or to the address defined in parameter GPRS testing IP address, if different than 0.0.0.0. In „Proxy“ mode, the frame is sent to Proxy server IP address.</p> <p>No reply to sent frame after exercising defined timeout and number of retries is considered as transmission failure and sets triggering input FS1_gprs 0--> 1, that can be used for Rules processing (SMS sending). As a consequence, after elapsing of time defined in Wait time after disconnection, the module performs RESET and commences GSM/GPRS login sequence.</p> <p>Reduction of this parameter increases the frequency of testing GPRS network state. This shortens possible disruptions of control due to network failures but increases "unproductive" data transmission.</p>

8.2.3.11. GPRS testing IP address

Function	- sets IP address where data frames testing GPRS network state are sent.
Data type	- IP address field
Range	- 0.0.0.0 - 255.255.255.255

- Default value** - 0.0.0.0
- Comments** - This parameter sets recipient's address for data frames testing GPRS transmission channel sent after defined Idle time elapses. Leaving recipient address at *0.0.0.0* sends data frames to module's own IP address. Any other valid address (within the APN) is accepted as the recipient.

8.2.3.12. Number of login retries

- Function** - Defines max. number of login to GPRS network retries. Each unsuccessful attempt changes the state of triggering input FS1_gprs from 0 to 1 and increases the failure counter by 1. After reaching declared value the module displays error code and awaits user action. Successful login resets failure counter.
- Data type** - number
- Range** - 0....255
- Default value** - 0
- Comments** - Setting the value to "0" results in endless retries

8.2.3.13. Wait time after disconnection

- Function** - Defines interval (in seconds) before resuming after failed login attempt.
- Data type** - number
- Range** - 0....60 [s]
- Default value** - 5 [s]
- Comments** - Setting the value to 0 results in immediate retries.

8.2.3.14. Data frame format

- Function** - This parameter selects data frame type used by module for GPRS communication, and indirectly the operating mode.
- Data type** - selection list
- Range** - *Standard*
Standard mode. Modules communicate using the protocol and transmission protection created by the manufacturer.
- Proxy*
mode allowing application in GPRS networks with dynamic IP assignment. This mode requires special communication software running on computer with static public address. Currently not supported.
- Open*
Configuration and operating modes as for Standard type frames. The only difference is lack of frame protection and opened UDP frame header format allowing creation of user's own access system.
- UDP Standard*
Data is send in form of ModbusRTU command encapsulated in standard UDP data frame. Data reception control is not available when using that data format.
- Default value** - *Standard*
- Comments** - More info about data formats employed in MT series can be found in chapter Appendices - Data formats

8.2.3.15. Proxy server IP address

Function	- inserts Proxy server IP for selected <i>Proxy</i> Data frame format.
Data type	- IP address field
Range	- 0.0.0.0 - 255.255.255.255
Default value	- 0.0.0.0
Comments	- inserted IP is public static address of communication server serving modules working in GSM/GPRS network with dynamic IP assignment.

8.2.3.16. CRC compatibility

Function	- This parameter sets CRC calculation for systems requiring full Modbus RTU compatibility.
Data type	- selection list
Range	- <i>Yes</i> For compatibility of Modbus RTU Slave mode, Modbus RTU Master mode and Modbus RTU Mirror mode with remaining modes, enabling the creation of systems consisting of modules working in transparent modes and Modbus RTU modes. This mode ensures compatibility with MT-DP communication software . <i>No</i> for maintaining compatibility when expanding existent systems operating in MODBUS modes or cooperating with old versions of OPC driver.
Default value	- <i>Yes</i>
Comments	- in new systems, it is recommended to leave the option at default value <i>Yes</i>

8.2.4. Authorized numbers

This group holds lists of telephone numbers and IP addresses authorized to communicate with the Module.

Lists form the basis for assignment of privileges for configuring, receiving data and sending commands.

Numbers on lists are the only ones allowed to be used for Rules processing.

8.2.4.1. Number of phone numbers

Function	- Defines length of phone number list that will receive SMS messages. Each phone number has defined privileges for SMS querying.
Data type	- number
Range	- 0....32
Default value	- 1
Comments	- The range value defines required volume of phone numbers used in SMS Rules processing. See more in Phone

8.2.4.2. Number of IP numbers

- Function** - Defines length of IP numbers list authorized to communicate with the module via GPRS. Particular IP addresses have defined privileges for access to configuration and sending data queries.
- Data type** - number
- Range** - 0....128
- Default value** - 1
- Comments** - The range value defines required volume of IP addresses used in Rules for Data transmission. See more in IP

8.2.4.3. Phone

- Idx** - list index number
- Name** - friendly name of the number facilitating identification in Rules processing. Max length - 16 characters.
- Number** - phone number assigned to index and name. Max 23 characters. Phone number may be a stored in the internal registers which allows dynamic changes of SMS recipient number. Number should be stored in the form of ASCII characters string. Characters are stored only on the younger byte of register. String should be ended with NULL character (0x0000).
- SMS request** - depending on check mark incoming SMS requests will be processed or ignored

The list may be edited using context menu activated by right mouse click. Available operations depend on the cursor placement. When cursor rests on an entry, all options are available, while only Append is available with cursor resting on active window's background.

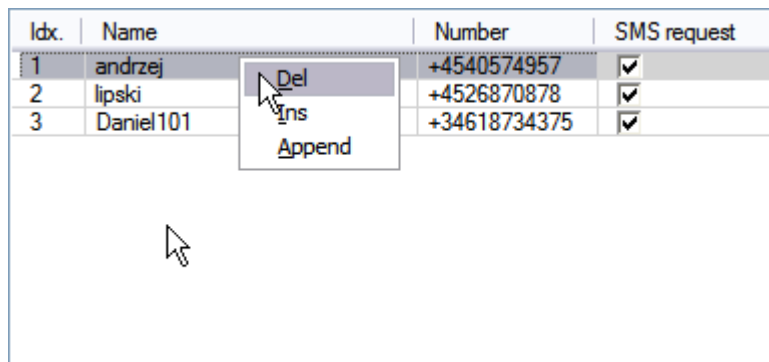

The screenshot shows a table with four columns: 'Idx', 'Name', 'Number', and 'SMS request'. The first row is selected, and a context menu is open over it, showing options: 'Del', 'Ins', and 'Append'. A mouse cursor is pointing at the 'Del' option.

Idx	Name	Number	SMS request
1	andrzej	+4540574957	<input checked="" type="checkbox"/>
2	lipski	+4526870878	<input checked="" type="checkbox"/>
3	Daniel101	+34618734375	<input checked="" type="checkbox"/>

8.2.4.4. IP

- Idx** - list index number
- Name** - friendly name of the IP number facilitating identification in Rules processing. Max length - 16 characters.
- Number** - number IP assigned to index and Name
- Configuration** - grants or denies right to perform remote configuration by this IP number
- Receiving** - depending on this setting, data incoming from this IP will be accepted or rejected

The list may be edited using context menu activated by right mouse click. Available operations depend on the cursor placement. When cursor rests on an entry, all options are available, while only Append is available with cursor resting on active window's background.

Idx.	Name	Number	Configuration	Sending	Receiving
1	master1	10.10.10.50	<input checked="" type="checkbox"/>	<input checked="" type="checkbox"/>	<input checked="" type="checkbox"/>
2	master2	10.10.35	<input checked="" type="checkbox"/>	<input checked="" type="checkbox"/>	<input checked="" type="checkbox"/>

8.2.5. Mode of operation

Group **Mode of operation** is not present on the list of parameter groups available for MT-101 configuration.

It is only present in this manual in order to collect parameters accessible dependent on selected operating Mode of operation.

In practice, only the group of parameters relevant for the selected mode will appear on the list.

8.2.5.1. Transparent mode

MT-101 operating in Transparent mode sends all data received at PORT2 to IP addresses appointed during configuration.

This is the standard operating mode employed as autonomic gateway between non-intelligent device connected to serial **port using not supported** by MT-101 protocol.

8.2.5.1.1. GPRS transmission

In transparent mode, the module receiving data at serial port buffers it in internal memory and converts it to data packet to be sent to defined recipients. During packets creation, criteria described by variables of **GPRS transmission** sub group are applied. Additionally, parameters allowing packet routing in order to reduce transmitted data volume are defined.

Packet routing is possible only when the place where where the address identifying final recipient in a disclosed mode is known.

8.2.5.1.1.1. Max. length of data packet

Function	- Defines (in bytes) maximal data volume in a packet. When data volume in receiving buffer reaches declared size, packet is sent.
Data type	- number
Range	- 1....1408
Default value	256
Comments	- n/a

8.2.5.1.1.2. Data packet delimiter

Function	- Defines (in seconds) the time between received characters. Reaching max. value triggers transmission of received data.
Data type	- number

Range	- 0,00....655,35 [s]
Default value	1 [s]
Comments	- n/a

8.2.5.1.1.3. Channel reservation time

Function	- Defines (in seconds) the time of reservation of exclusive transmission channel to device from which the frame was received.
Data type	- number
Range	- 0,00....655,35 [s]
Default value	0 [s]
Comments	- This parameter helps setting an exclusive transmission channel to one of remote devices for a period of time. This enables establishment of a system consisting of several devices with functionalities similar to point-to-point. When a channel is established, module ignores packets received from other devices and all data received at PORT 2 are sent to the module with which the channel is established. Transmission costs are thus reduced significantly. Packets are sent to all recipients only at first transmission. The function is activated by setting the value other to than zero thus defining the time channel is reserved. Time count starts from receiving first GPRS packet. Consecutive packets from same source prolong reservation time while sent packets do not. Setting this variable to 0 switches reservation off and module operates in standard way sending and receiving packets to all defined recipients.

8.2.5.1.1.4. Routing

Function	- enables choosing method of recording recipients address in transmitted data frame.
Data type	- number
Range	- <i>n/a</i> Transparent mode without routing <i>8 bit Address</i> The Address is 8 bit long (one byte) <i>16 bit HL Address</i> The Address is 16 bit long (two bytes) in sequence „High“ and „Low“ byte <i>16 bit LH Address</i> The Address is 16 bit long (two bytes) in sequence „Low“ and „High“ byte
Default value	<i>n/a</i>
Comments	- setting the parameter to <i>n/a</i> switches routing off

CAUTION!

When channel reservation and Routing are used simultaneously, channel reservation has higher priority. Routing table is used only without channel reservation! In case of channel reservation, all frames are sent to one recipient regardless format and length of the frame. After channel is released (after channel reservation time has elapsed), the recipient is found on the basing of the address field of received frame.

8.2.5.1.1.5. Address offset

Function	- defines the offset of address field in transmitted data frame
Data type	- number
Range	- 0....1407
Default value	0
Comments	- too short frames with lengths not encompassing address field which are ignored. Pay attention to proper setting of Max. length of data packet and Data packet delimiter so that all data frames will be received completely.

8.2.5.1.1.6. Broadcast address

Function	- Defines recipient address. If detected in address field of the frame received at PORT 2 will cause sending of this frame to all recipients defined in routing table.
Data type	- number
Range	- 0....65535
Default value	0
Comments	- Placing this address in routing table will result in sending all transmitted frames to corresponding IP address.

8.2.5.1.1.7. Routing table size

Function	- Defines size of routing table
Data type	- number
Range	- 1....256
Default value	- 1
Comments	- the length of routing table should not be shorter than number of network nodes the module communicates with.

8.2.5.1.2. Routing table

Idx	- index number of the list
number IP	- IP address of GPRS network node
number ID	- ID number of device connected to GPRS network node with given IP address
Comments	- n/a

CAUTION!
When channel reservation and Routing are used simultaneously, channel reservation has higher priority. Routing table is used only without channel reservation! In case of channel reservation, all frames are sent to one recipient regardless of format and length of the frame. After channel is released (after channel reservation time has elapsed), the recipient is found on the basis of the address field of received frame.

8.2.5.2. Modbus RTU Master mode

MT-101 Module operating in **Modbus RTU Master** mode receives data sent by peripheral device operating in Modbus RTU Master mode at PORT2. Data are sent via GPRS to remote Slave devices according to routing table.

Module MT-101 operating in this mode acts as intelligent GPRS communication gateway allowing physical separation of Modbus RTU network nodes. Module's internal resources have assigned Modbus ID which allows reading them from PORT2.

8.2.5.2.1. Routing table size

Function	- Defines size of routing table
Data type	- number
Range	- 1....255
Default value	- 1
Comments	- the length of routing table should not be shorter than number of network nodes the module communicates with.

8.2.5.2.2. Routing table

Idx	- index number of the list
number IP	- IP address of GPRS network node
number ID	- Modbus ID number (0-255) of slave device connected to GPRS network node with given IP address
Comments	- entering Modbus ID of one of the Slave devices connected to PORT2 (including internal module resources) results in sending replies from that ID to specified IP address regardless of the address of inquiring unit. Setting this value to <i>0 (zero)</i> , makes the module with specified IP address receive all frames sent by Master unit regardless of Modbus addressing.

8.2.5.3. Modbus RTU Slave mode

MT-101 Module operating in **Modbus RTU Slave** mode sends all received via GPRS queries to PORT2, except those that have Modbus IDs identical with module's own Modbus ID of internal resources in address field - since they are handled locally. replies received at PORT 2 from peripheral Slave devices along with replies from internal module resources are sent to the address from which query was issued or according to Routing Table content.

8.2.5.3.1. Routing table size

Function	- Defines size of routing table
Data type	- number
Range	- 1....255
Default value	- 1
Comments	- the length of routing table should not be shorter than number of network nodes the module communicates with.

8.2.5.3.2. Routing table

Idx	- index number of the list
number IP	- IP address of GPRS network node
number ID	- Modbus ID number (0-255) of slave device connected to GPRS network node with given IP address
Comments	- In basic configuration where replies are sent only to inquirer the table may remain empty. The table needs to be filled out when replies have to be sent to other Masters. Second column holds IP address of auxiliary master, while third column - Modbus ID of device which answer has to be sent additionally to auxiliary master. If third column has value <i>0 (zero)</i> , replies from all connected to module slaves and module's internal resources will be sent to appointed IP address. Sending replies to any number of Master devices is possible (Multimaster mode).

8.2.5.4. Modbus RTU Mirror mode

Modbus RTU Mirror is an extension of Modbus RTU Slave mode. The behavior of the module is identical to Modbus RTU Slave mode seen from the GPRS point of view. Remote access to internal module resources and to Slave devices connected to PORT 2 is secured. An additional feature is the opportunity to map resources of slave devices connected to PORT 2 into internal module registers. Upon activation of this option, the module cyclically reads mapped areas and refreshes internal registers. Read more about Modbus RTU Mirror mode ...

8.2.5.4.1. Number of data blocks

Function	- Defines number of registers read from peripheral Slave devices via PORT2
Data type	- number
Range	- 1....16
Default value	- 1
Comments	- n/a

8.2.5.4.2. Delay after error in communication with SLAVE

Function	- Defines (in seconds) delay before reestablishing reading of registers in peripheral Slave devices after transmission errors.
-----------------	--

Time is counted independently for each defined area (Slave device) and reduces only the frequency of querying for areas with communication errors.

Data type	- number
Range	- 1....65535 [s]
Default value	15 [s]
Comments	- Increasing this value reduces influence of malfunctioning devices on communication with other devices but decreases statistic time to reestablish communication after removal of error cause.

8.2.5.4.3. Data block 1...16

The table defining sequential data blocks read from attached to PORT2 peripheral Slave devices allows defining of 1 to 16 independent blocks in one or more devices. Consecutive blocks may encompass registers from different spaces and be refreshed at different intervals.

8.2.5.4.3.1. Modbus ID of Slave device

Function	- Defines Modbus ID of Slave device from which configured data block is to be read
Data type	- number
Range	- 0....255
Default value	- 0
Comments	- setting Modbus ID to <i>0 (zero)</i> switches the mapping off

8.2.5.4.3.2. Space

Function	- selects Modbus space mapped from peripheral Slave device attached to PORT2
Data type	- selection list
Range	- <i>Bi In</i> Binary inputs (1xxx), read-only <i>Bi Out</i> Binary outputs (0xxx), read and write <i>Inp. Reg.</i> Input Registers (3xxx), read-only <i>Hold. Reg.</i> Internal Registers (4xxx), read and write
Default value	- <i>Bi In</i>
Comments	- writing into registers mapping read-only spaces does not cause an error. Values will be replaced by next error-free reading from peripheral device.

8.2.5.4.3.3. Address of mapped space in module

Function	- defines start address of internal register in the module, used for mapping space from the Slave. For mapping space Internal registers are always used.
-----------------	--

Data type - number
Range - 0....999
Default value - 1
Comments - n/a

8.2.5.4.3.4. Address of mapped space in SLAVE

Function - Defines address of first register mapped from peripheral Slave device.
Data type - number
Range - 0....65535
Default value - 0
Comments - n/a

8.2.5.4.3.5. Mapped space size

Function - Defines the size of register space necessary for reading mapped space from peripheral Slave device.
Data type - number
Range - 1....2040
Default value - 1
Comments - for register space, value of this variable defines size of mapped space in Registers while for bitmapped in bits. Bits from mapped space are placed on consecutive bits in registers (starting from least significant).
 So, in module in one registers 16 bits are stored.
 Typical layout of mapped bit space:
 Address of mapped space module: 64
 Address of mapped space SLAVE: 3
 Size of mapped space: 20

8.2.5.4.3.6. Mapped space read interval

Function - Defines (in seconds) read interval of peripheral Slave device for update.
Data type - number
Range - 0....65535 [s]
Default value - 1 [s]
Comments - value 0 (*zero*) forces max. possible frequency of updating. It depends on speed of PORT2 along with size and number of defined mapped spaces.

8.2.5.5. Transparent PLUS mode

Transparent PLUS mode is an extension of standard Transparent mode, with access to internal module resources using standard Modbus frames.

8.2.5.5.1. Max. length of data packet

Function	- Defines (in bytes) max. data volume in a packet. When reception buffer reaches declared value, the packet will be dispatched.
Data type	- number
Range	- 0....1408
Default value	256
Comments	- n/a

8.2.5.5.2. Data packet delimiter

Function	- Defines (in seconds) time between received characters. Exceeding this value triggers transmission of received data.
Data type	- number
Range	- 0,00....655,35 [s]
Default value	1,00 [s]
Comments	- n/a

8.2.5.5.3. Channel reservation time

Function	- Defines (in seconds) the time of reservation of exclusive transmission channel to device from which the frame was received.
Data type	- number
Range	- 0,00....655,35 [s]
Default value	0,00 [s]
Comments	- This parameter helps set an exclusive transmission channel to a remote device for a period of time. This enables establishing a system consisting of several devices with functionality similar to point-to-point. When a channel is established, the module ignores packets received from other devices and all data received at PORT 2 are sent to the module with which the channel is established. Transmission costs are thus reduced significantly. Packets are sent to all recipients only at first transmission. The function is activated by setting the value to other than zero thus defining the time channel is reserved. Time count starts from receiving first GPRS packet. Consecutive packets from same source prolong reservation time while sent packets do not. Setting this variable to 0 switches reservation off and module operates in standard way sending and receiving packets to all defined recipients. The function of channel reservation is independent on module access frames. Reception of such frame does not reserve the channel. Access to module from other master is possible when channel is reserved.

8.2.5.6. GazModem mode

CAUTION!
Option discontinued from v 1.43 of firmware for module MT-101.
The description is solely for legacy support .

MT-101 Module operating in **GazModem mode** enables communication with gas counters operating on GazModem transmission protocol. Data received at PORT2 are placed in respective registers of MT-101 module's memory map.

8.2.5.6.1. Read interval

Function	- Defines (in seconds) an interval between readings from peripheral device operating on GazModem protocol in order to update measurement data.
Data type	- number
Range	- 0....65535 [s]
Default value	- 180 [s]
Comments	- value <i>0 (zero)</i> forces max. possible frequency of updating. It depends on speed of PORT2 along with size and number of defined mapped spaces.

8.2.5.6.2. Number of retries

Function	- defines number of attempts to transmit data via PORT2 in case of unconfirmed (within time defined by transmission Timeout parameter) reception.
Data type	- number
Range	- 0....7
Default value	- 2
Comments	- value <i>0 (zero)</i> forces max. possible frequency of updating. It depends on speed of PORT2 along with size and number of defined mapped spaces.

8.2.5.6.3. Transmission timeout

Function	- Defines (in seconds) waiting time for confirmation of data frame reception.
Data type	- number
Range	- 0....10 [s]
Default value	- 2 [s]
Comments	- This value along with declared Number of retries influences max. time of single data packet transmission.

8.2.5.6.4. Threshold hysteresis

Function	- Defines hysteresis for alarm thresholds values
Data type	- number

Range	- 0,01...100,00 [%]
Default value	- 2,00 [%]
Comments	- setting of value of hysteresis adequate to signal variations prevents untimely activations of alarm flags.

8.2.5.6.5. Alarm station IP address

Function	- defines alarm recipient's IP address.
Data type	- selection list
Range	- friendly names assigned to IP addresses of devices declared in Authorized numbers list
Default value	- IP1 - first number on authorized numbers list
Comments	- since recipient's IP address is selected from selection list, it is practical to define unique unambiguous names facilitating identification on the list.

8.2.5.6.6. Number of devices

Function	- Defines number of declared register spaces (devices) read on PORT2 from peripheral devices operating on GazModem protocol
Data type	- number
Range	- 1....16
Default value	- 1
Comments	- n/a

8.2.5.6.7. MC 1....16

The table defining consecutive data blocks read from peripheral devices attached to PORT2 operating in GazModem protocol. The table can hold from 1 to 16 independent blocks in one or more devices. Consecutive blocks may encompass Registers from different spaces.

8.2.5.6.7.1. Address

Function	- Defines address of gas counter from which the configured data block should be read
Data type	- number
Range	- 0....65535
Default value	- 0
Comments	- n/a

8.2.5.6.7.2. Alarm reading

Function	- defines status of alarm reading from gas meter
Data type	- selection list

Range	- <i>Yes</i> Reading active <i>No</i> Reading inactive
Default value	- <i>No</i>
Comments	- n/a

8.2.5.6.7.3. Signal reading

Function	- defines status of signal reading from gas meter
Data type	- selection list
Range	- <i>No</i> Signal reading inactive <i>1 byte</i> Read 1 signal byte in Gaz-Modem protocol <i>2 bytes</i> Read 2 signal bytes in Gaz-Modem protocol <i>3 bytes</i> Read 3 signal bytes in Gaz-Modem protocol <i>4 bytes</i> Read 4 signal bytes in Gaz-Modem protocol <i>Gazmodem 2</i> Read signals in Gaz-Modem2 protocol
Default value	- <i>No</i>
Comments	- n/a

8.2.5.6.7.4. Current data reading

Function	- sets status of current data reading from gas meter
Data type	- selection list
Range	- <i>Yes</i> Current data reading active <i>No</i> Current data reading inactive
Default value	- <i>No</i>
Comments	- n/a

8.2.5.6.7.5. Current data block index

Function	- Defines address of first current data register from peripheral GazModem device
Data type	- number
Range	- 0...64
Default value	- 0
Comments	- n/a

8.2.5.6.7.6. Current data block length

Function	- Defines size of current data block read from peripheral GazModem device
Data type	- number
Range	- 1....8
Default value	- 1
Comments	- n/a

8.2.5.7. M-Bus LEC mode

CAUTION!
This option is not supported since firmware 1.43 in MT-101 modules.
The following description is published for legacy support.

MT-101 module operating in **M-Bus LEC mode** along with converter RM-102 plays the role of data converter for data received from heat meters that employ M-Bus protocol. Data received at PORT2 is placed in dedicated registers of the memory map of MT-101. Additionally, in this mode it is possible to attach a gas meter to PORT1 of the MT-101 module. After selecting this mode, local configuration is possible during the first 30s after power-up - PWR LED is flashing.

8.2.5.7.1. Read interval

Function	- Defines (in seconds) an interval between readings from peripheral device operating on GazModem protocol in order to update measurement data.
Data type	- number
Range	- 0....255 [min]
Default value	- 5 [min]
Comments	- value <i>0 (zero)</i> forces max. possible frequency of updating. It depends on speed of PORT2 along with size and number of defined mapped spaces.

8.2.5.7.2. Number of retries

Function	- defines number of attempts to transmit data via PORT2 in case of unconfirmed (within time defined by transmission Timeout parameter) reception.
Data type	- number
Range	- 0....7
Default value	- 1
Comments	- value <i>0</i> results in sending without confirming faultless reception.

8.2.5.7.3. Transmission timeout

Function	- Defines (in seconds) waiting time for confirmation of data frame reception.
Data type	- number
Range	- 0....10 [s]

Default value	- 2 [s]
Comments	- This value along with declared Number of retries influences max. time of single data packet transmission.

8.2.5.7.4. Threshold hysteresis

Function	- Defines hysteresis for alarm thresholds values
Data type	- number
Range	- 0,01...100,00 [%]
Default value	- 5,00 [%]
Comments	- setting of value of hysteresis adequate to signal variations prevents untimely activations of alarm flags.

8.2.5.7.5. Gas meter address

Function	- Defines address of gas meter connected to module's PORT 1
Data type	- number
Range	- 0...65535
Default value	- 0
Comments	- n/a

8.2.5.7.6. Gas meter reading interval

Function	- Defines (seconds) interval of readings from peripheral device using GazModem protocol for update measurement data. The connection is via PORT 1
Data type	- number
Range	- 0...65535 [s]
Default value	- 180 [s]
Comments	- value <i>0 (zero)</i> forces max. possible frequency of updating. It depends on speed of PORT2 along with size and number of defined mapped spaces.

8.2.5.7.7. Number of transmission retries to gas meter

Function	- defines number of attempts to transmit data via PORT1 in case of unconfirmed (within time defined by Transmission timeout to gas meter parameter) reception.
Data type	- number
Range	- 0...7
Default value	- 2
Comments	- value <i>0</i> results in sending without confirming faultless reception.

8.2.5.7.8. Transmission timeout for gas meter

Function	- Defines (in seconds) waiting time for confirmation of data frame reception at PORT1.
Data type	- number
Range	- 0,01....10,00 [s]
Default value	- 2,00 [s]
Comments	- This value along with declared Number of transmission retries to gas meter influences max. time of single data packet transmission.

8.2.5.7.9. Number of devices

Function	- Defines number of declared register spaces (devices) read on PORT2 from peripheral devices operating on M-Bus protocol.
Data type	- number
Range	- 1....16
Default value	- 1
Comments	- n/a

8.2.5.7.10. MC

The table defining consecutive data blocks read from peripheral devices attached to PORT2 operating in M-Bus protocol. The table can hold from 1 to 16 independent blocks in one or more devices.

8.2.5.7.10.1. Address 1....16

Function	- Defines address of heat meter whose internal parameters shall be read.
Data type	- number
Range	- 0....255
Default value	- 0
Comments	- address 255 means querying stopped

8.2.5.7.10.2. Geographical coordinates format

Function	- Defines format of geographical coordinates received in NMEA 0183 protocol when writing into registers.
Data type	- selection list
Range	- <i>Degrees.minutes (DDMM.mmmmm)</i> Position registered in format <i>Degrees (DD.ddddddd)</i> Position registered in format
Default value	- <i>Degrees.minutes (SSMM.mmmmm)</i>
Comments	- n/a

8.2.5.7.10.3. Identifier 1....16

Function	- Defines additional number of heat meter whose internal parameters shall be read.
Data type	- number
Range	- 0....999999999
Default value	- 0
Comments	- Parameter enables addition of auxiliary identifier for heat meter in telemetry system. The parameter is in no way connected to real address of meter. The value of parameter is stored in MT module and can be read from its memory map.

8.2.5.8. NMEA 0183 mode

Module MT-101 operating in **NMEA 0183** mode receives data from peripheral devices using communication protocol compliant with NMEA 0183 at PORT2. The module recognizes data received from AIRMAR weather station and places it in Internal registers. Read more about NMEA 0183 mode...

8.2.5.8.1. Data validity time

Function	- Defines (in seconds) validity time of parameters read from NMEA frames received at PORT2. When exceeded due to incomplete reception, relevant bits signal that values in registers are out of date. In other words, older than the time declared in configuration.
Data type	- number
Range	- 1....300
Default value	2
Comments	- n/a

8.2.5.9. FlexSerial

In **FlexSerial mode** MT-101 module can service units connected to PORT2 that employ non standard protocols. More about FlexSerial mode...

8.2.5.9.1. Max. length of data packet

Function	- defines (in bytes) max length of data packet in receiving buffer.
Data type	- number
Range	- 1....512
Default value	256
Comments	- none

8.2.5.9.2. Data packet delimiter

Function	- Defines (in seconds) interval between incoming bytes. Exceeding this interval results in storing incomplete data packet in receiving buffer
-----------------	---

Data type	- number
Range	- 0,00....655,35 [s]
Default value	1 [s]
Comments	- none

8.2.6. Resources

Group **Resources** encompasses a list of hardware and software resources available to users. Sub-groups hold configurable parameters for Inputs/outputs, asynchronous and synchronous Timers, Registrator, MT2MT Buffer and Constant parameters.

8.2.6.1. Modbus ID number of module's internal resources

Function	- Defines Modbus ID number for internal resources of the module operating in Modbus Slave mode.
Data type	- number
Range	- 0....255
Default value	- 1
Comments	- setting Modbus ID to <i>0 (zero)</i> makes access to internal module resources impossible

8.2.6.2. Terminals

Sub-group Terminals gathers all inputs and outputs. Depending on type of accepted input, they are binary and analogue. Final functionality of each input depends on settings and configuration parameters connected.

8.2.6.2.1. Binary inputs I1,...I8

Module **MT-101** has eight identical Binary inputs. Inputs can operate in one of three functional modes:

- Standard binary input
- counter input
- analogue input with conversion of frequency to analogue value

Each mode has a set of specific configuration parameters.

8.2.6.2.1.1. Name

Function	- Enables entering a friendly input name e.g. connected to the function performed. The name is displayed on list of terminals.
Data type	- text
Range	- letters and numerals, max.16 characters
Default value	- Name of resource (I1....I8)
Comments	- Using friendly names facilitates recognition of destination and appropriate settings.

8.2.6.2.1.2. Operating modes

Function	- defines operating mode for inputs I1....I8
Data type	- selection list

- Range** - *Binary input*
the input acts as typical binary input accepting positive and negative logic.
Analogue input
the input acts as analogue input, measuring frequency of incoming signal in range from 0....2 kHz.
Counter input
the input acts as counter input. Each pulse appearing on input increments value of corresponding 32 bit register
- Default value** - *Binary input*
- Comments** - selecting appropriate operating mode is the basis for taking full advantage of module capabilities. It has an influence on available configuration parameters optimizing module performance.

8.2.6.2.1.2.1. Binary input

8.2.6.2.1.2.1.1. Filtering constant

- Function** - Defines (in seconds) value of min. duration of altered state on input in order to consider state to be stable.
- Data type** - number
- Range** - 0,00....163 [s]
- Default value** - 0,00 [s]
- Comments** - Setting value appropriate to contact characteristics eliminates disturbance caused by contact bounce thus preventing multiple registration of what is in reality one pulse.

8.2.6.2.1.2.2. Analogue inputs

- Function** - Defines filter filtering constant
- Data type** - number
- Range** - 0,0...25,5 [s]
- Default value** - 0
- Comments** - for *0 (zero)* value filtering is off.
Setting high time value influences stabilizing of result after signal value change, but allows better precision of measuring noisy signal.
It is recommended to set filtering constant to value *6,4* and higher to provide satisfying precision of measurements.
Assuming that measured value will raise from minimum to maximum value (unit step), value from measurement will achieve X% of real value within time specified by table:

Time of measurement	Percent of real value
1 filtering constant	63,2%
2 filtering constants	86,5%
3 filtering constants	95,0%
4 filtering constants	98,2%
5 filtering constants	99,3%

8.2.6.2.1.2.2.1. Engineering units

- Function** - Defines name for engineering units
Data type - text
Range - letters and numerals, max 16 characters
Default value - x
Comments - inserted text does not have any influence on the value of measured analogue signal

8.2.6.2.1.2.2.2. Low reference - internal units

- Function** - used along with other reference parameters for rescaling input signal range to engineering units range.
Data type - number
Range - 0...65535
Default value - 0
Comments - low reference point for internal units

8.2.6.2.1.2.2.3. Low reference - engineering units

- Function** - used along with other reference parameters for rescaling input signal range to engineering units range.
Data type - number
Range - 0...65535
Default value - 400
Comments - low reference point for engineering units

8.2.6.2.1.2.2.4. High reference - internal units

- Function** - used along with other reference parameters for rescaling input signal range to engineering units range.
Data type - number
Range - 1...65535
Default value - 65535
Comments - high reference point for internal units

8.2.6.2.1.2.2.5. High reference - engineering units

- Function** - used along with other reference parameters for rescaling input signal range to engineering units range.
Data type - number
Range - 1...65535
Default value - 2000
Comments - high reference point for engineering units

8.2.6.2.1.2.2.6. Alarm HiHi

- Function** - Defines **HiHi** alarm level in engineering units for analogue input signal.
- Data type** - number
- Range** - 0....65535 [engineering units]
- Default value** - 0 [engineering units]
- Comments** - Sets *A HiHi* flag used for rules processing. The level of reset for this flag depends on Alarm hysteresis value.

8.2.6.2.1.2.2.7. Alarm Hi

- Function** - Defines **Hi** alarm level in engineering units for analogue input signal.
- Data type** - number
- Range** - 0....65535 [engineering units]
- Default value** - 0 [engineering units]
- Comments** - Sets *A Hi* flag used for rules processing. The reset level for this flag depends on Alarm hysteresis value.

8.2.6.2.1.2.2.8. Alarm Lo

- Function** - Defines **Lo** alarm level in engineering units for analogue input signal.
- Data type** - number
- Range** - 0....65535 [engineering units]
- Default value** - 0 [engineering units]
- Comments** - Sets *An Lo* flag used for rules processing. The reset level for this flag depends on Alarm hysteresis value.

8.2.6.2.1.2.2.9. Alarm LoLo

- Function** - Defines **LoLo** alarm level in engineering units for analogue input signal.
- Data type** - number
- Range** - 0....65535 [engineering units]
- Default value** - 0 [engineering units]
- Comments** - Sets *An Lo* flag used for rules processing. The reset level for this flag depends on Alarm hysteresis value.

8.2.6.2.1.2.2.10. Alarm hysteresis

- Function** - Defines hysteresis for analogue input alarm thresholds. The value is in engineering units.
- Data type** - number
- Range** - 1....65535 [engineering units]

Default value - 10 [engineering units]
Comments - setting proper hysteresis value for variable signal source prevents frequent activation of alarm flag when signal source is unstable.

8.2.6.2.1.2.2.11. Dead band

Function - Defines size of dead band for value of analogue input in engineering units.
Data type - number
Range - 0...65534 [engineering units]
Default value - 10 [engineering units]
Comments - Insensitivity band spans symmetrically with last recorded value in center. Upon crossing this value, the new value is recorded and insensitivity band is moved. The *An DB* flag in binary inputs space is raised and may be used for rules processing.

8.2.6.2.1.2.3. Counter inputs

8.2.6.2.1.2.3.1. Counting direction

Function - defines counting direction
Data type - selection list
Range - *Up*
A pulse on input increases value of counter register
Down
A pulse on input decreases value of counter register
Default value - *Up*
Comments - The counting process is valid only within range of Counting range parameter.

8.2.6.2.1.2.3.2. Counting range

Function - defines max. value assumed by the counter
Data type - number
Range - 0...2 147 483 647 (31 bits + counting direction bit)
Default value - 0
Comments - when counting up the counter is zeroed by next appearing pulse upon reaching declared value. When counting down, next pulse writes declared value into the counter upon reaching 0. *0 (zero)* value switches counting off.

8.2.6.2.1.2.3.3. Activating slope

Function - selects counting direction
Data type - selection list

- Range** - *Raising*
The change of counter state occurs upon signal change from 0 --> 1
- Falling*
The change of counter state occurs upon signal change from 1 --> 0
- Default value** - *Raising*
- Comments** - n/a

8.2.6.2.1.2.3.4. Filtering constant

- Function** - Defines (in seconds) value of min. duration of altered state on input in order to consider state to be stable.
- Data type** - number
- Range** - 0,00....163,83 [s]
- Default value** - 0,00 [s]
- Comments** - Setting value appropriate to contact characteristics eliminates disturbance caused by contact bounce thus preventing multiple registration of what is in reality one pulse.

8.2.6.2.2. Binary outputs Q1....Q8

MT-101 Module has eight functionally identical Binary outputs. These inputs can operate in one of four modes:

- standard binary input
- analogue input with conversion of frequency to analogue value
- counter input
- standard binary output

Each mode has a set of specific configuration parameters.

8.2.6.2.2.1. Name

- Function** - Enables entering friendly name of input e.g. connected to the function performed. The name is displayed on terminals list.
- Data type** - text
- Range** - letters and numerals, max.16 characters
- Default value** - Name of resource (Q1....Q8)
- Comments** - Using friendly names facilitates recognition of destination and appropriate settings.

8.2.6.2.2.2. Operating modes

- Function** - defines operating mode for outputs Q1....Q8
- Data type** - selection list
- Range** - *Binary input*
the input acts as typical binary input accepting positive and negative logic.

Analogue input

the input acts as analogue input, measuring frequency of incoming signal in range from 0....2 kHz.

Counter input

the input acts as counter input. Each pulse appearing on input increments value of corresponding 32 bit register

Binary output

the output acts as typical binary output in positive logic.

Default value - *Binary output*

Comments - selecting appropriate operating mode is the basis for taking full advantage of module capabilities. It has an influence on available configuration parameters optimizing module performance.

8.2.6.2.2.2.1. Binary input

Function - Defines (in seconds) value of min. duration of altered state on input in order to consider state to be stable.

Data type - number

Range - 0,00....163,83 [s]

Default value - 0,1 [s]

Comments - Setting value appropriate to contact characteristics eliminates disturbance caused by contact bounce thus preventing multiple registration of what is in reality one pulse.

8.2.6.2.2.2.2. Analogue inputs

Function - Defines filter filtering constant

Data type - number

Range - 0,0...25,5 [s]

Default value - 0

Comments - for *0 (zero)* value filtering is off.
Setting high time value influences stabilizing of result after signal value change, but allows better precision of measuring noisy signal.
It is recommended to set filtering constant to values *6,4* and higher to provide satisfying precision of measurements.
Assuming that measured value will raise from minimum to maximum value (unit step), value from measurement will achieve X% of real value within time specified by table:

Time of measurement	Percent of real value
1 filtering constant	63,2%
2 filtering constants	86,5%
3 filtering constants	95,0%
4 filtering constants	98,2%
5 filtering constants	99,3%

8.2.6.2.2.2.1. Engineering units

- Function** - Defines a name for engineering units
Data type - text
Range - letters and numerals, max 16 characters
Default value - x
Comments - inserted text does not have any influence on the value of measured analogue signal

8.2.6.2.2.2.2. Low reference - internal units

- Function** - used along with other reference parameters for rescaling input signal range to engineering units range.
Data type - number
Range - 0....65535
Default value - 0
Comments - low reference point for internal units

8.2.6.2.2.2.3. Low reference - engineering units

- Function** - used along with other reference parameters for rescaling input signal range to engineering units range.
Data type - number
Range - 0....65535
Default value - 400
Comments - low reference point for engineering units

8.2.6.2.2.2.4. High reference - internal units

- Function** - used along with other reference parameters for rescaling input signal range to engineering units range.
Data type - number
Range - 1....65535
Default value - 65535
Comments - high reference point for internal units

8.2.6.2.2.2.5. High reference - engineering units

- Function** - used along with other reference parameters for rescaling input signal range to engineering units range.
Data type - number
Range - 1....65535
Default value - 2000
Comments - high reference point for engineering units

8.2.6.2.2.2.6. Alarm HiHi

- Function** - Defines **HiHi** alarm level in engineering units for analogue input signal.
- Data type** - number
- Range** - 0....65535 [engineering units]
- Default value** - 0 [engineering units]
- Comments** - Sets *An HiHi* flag used for rules processing. The reset level for this flag depends on Alarm hysteresis value.

8.2.6.2.2.2.7. Alarm Hi

- Function** - Defines **Hi** alarm level in engineering units for analogue input signal.
- Data type** - number
- Range** - 0....65535 [engineering units]
- Default value** - 0 [engineering units]
- Comments** - Sets *An Hi* flag used for rules processing. The reset level for this flag depends on Alarm hysteresis value.

8.2.6.2.2.2.8. Alarm Lo

- Function** - Defines **Lo** alarm level in engineering units for analogue input signal.
- Data type** - number
- Range** - 0....65535 [engineering units]
- Default value** - 0 [engineering units]
- Comments** - Sets *An Lo* flag used for rules processing. The reset level for this flag depends on Alarm hysteresis value.

8.2.6.2.2.2.9. Alarm LoLo

- Function** - Defines **LoLo** alarm level in engineering units for analogue input signal.
- Data type** - number
- Range** - 0....65535 [engineering units]
- Default value** - 0 [engineering units]
- Comments** - Sets *An LoLo* flag used for rules processing. The reset level for this flag depends on Alarm hysteresis value.

8.2.6.2.2.2.10. Alarm hysteresis

- Function** - Defines hysteresis for analogue input alarm thresholds. The value is in engineering units.
- Data type** - number
- Range** - 1....65535 [engineering units]
- Default value** - 10 [engineering units]

Comments - setting proper hysteresis value for variable signal source prevents frequent activation of alarm flag when signal source is unstable.

8.2.6.2.2.2.11. Dead band

Function - Defines size of dead band for values of analogue input in engineering units.

Data type - number

Range - 0...65534 [engineering units]

Default value - 10 [engineering units]

Comments - Insensitivity band spans symmetrically with last recorded value in center. Upon crossing this value, the new value is recorded and insensitivity band is moved. The *An DB* flag in binary inputs space is raised and may be used for rules processing.

8.2.6.2.2.2.3. Counter inputs

8.2.6.2.2.2.3.1. Counting direction

Function - defines counting direction

Data type - selection list

Range - *Up*

A pulse on input increases value of counter register

Down

A pulse on input decreases value of counter register

Default value - *Up*

Comments - The counting process is valid only within range of Counting range parameter.

8.2.6.2.2.2.3.2. Counting range

Function - defines max. value assumed by the counter

Data type - number

Range - 0...2 147 483 647 (31 bits + counting direction bit)

Default value - 0

Comments - when counting up, the counter is zeroed by next appearing pulse upon reaching declared value. When counting down, next pulse writes declared value into the counter upon reaching 0. *0 (zero)* value switches counting off.

8.2.6.2.2.2.3.3. Activating slope

Function - selects counting direction

Data type - selection list

Range - *Raising*

The change of counter state occurs upon signal change from 0 --> 1

Falling

The change of counter state occurs upon signal change from 1 --> 0

Default value - *Raising*

Comments - n/a

8.2.6.2.2.3.4. Filtering constant

Function - Defines (in seconds) value of min. duration of altered state on input in order to consider state to be stable.

Data type - number

Range - 0,00....163,83 [s]

Default value - 0,00 [s]

Comments - Setting value appropriate to contact characteristics eliminates disturbance caused by contact bounce thus preventing multiple registration of what is in reality one pulse.

8.2.6.2.2.4. Binary outputs

Binary outputs do not require any configuration.

8.2.6.2.3. Analogue inputs AN1, AN2

MT-101 Module is equipped with two identical Analogue inputs operating in 4-20mA standard.

8.2.6.2.3.1. Name

Function - allows setting a friendly name for the input usually connected with performed function. Assigned name appears on the terminals list

Data type - text

Range - letters and numerals, max. 16 characters

Default value - Resource Name (A1, A2)

Comments - entering a friendly name facilitates distinguishing destination, performed function and required settings.

8.2.6.2.3.2. Filtering constant

Function - Defines filter filtering constant

Data type - number

Range - 0,0...25,5 [s]

Default value - 0

Comments - for *0 (zero)* value filtering is off. Setting high time value influences stabilizing of result after signal value change, but allows better precision of measuring noisy signal.

Assuming that measured value will raise from minimum to maximum value (unit step), value from measurement will achieve X% of real value within time specified by table:

Time of measurement	Percent of real value
1 filtering constant	63,2%
2 filtering constants	86,5%
3 filtering constants	95,0%
4 filtering constants	98,2%
5 filtering constants	99,3%

8.2.6.2.3.3. Operating mode

- Function** - defines analogue inputs operating mode
- Data type** - selection list
- Range** - *Analogue input*
the input operates as 4-20 mA standard input
- Default value** - *Analogue input*
- Comments** - Parameter preserved for legacy support, not important for operating analogue inputs A1, A2

8.2.6.2.3.4. Engineering units

- Function** - Defines a name for engineering units for measured values.
- Data type** - text
- Range** - letters and numerals, max 16 characters
- Default value** - x
- Comments** - inserted text does not have any influence on the value of measured analogue signal

8.2.6.2.3.5. Low reference - internal units

- Function** - used along with other reference parameters for rescaling input signal range to engineering units range.
- Data type** - number
- Range** - 0...65535
- Default value** - 0
- Comments** - low reference point for internal units

8.2.6.2.3.6. Low reference - engineering units

- Function** - used along with other reference parameters for rescaling input signal range to engineering units range.
- Data type** - number
- Range** - 0...65535
- Default value** - 400
- Comments** - low reference point for engineering units

8.2.6.2.3.7. High reference - internal units

Function	- used along with other reference parameters for rescaling input signal range to engineering units range.
Data type	- number
Range	- 1....65535
Default value	- 65535
Comments	- high reference point for internal units

8.2.6.2.3.8. High reference - engineering units

Function	- used along with other reference parameters for rescaling input signal range to engineering units range.
Data type	- number
Range	- 1....65535
Default value	- 2000
Comments	- high reference point for engineering units

8.2.6.2.3.9. Alarm HiHi

Function	- Defines HiHi alarm level in engineering units for analogue input signal.
Data type	- number
Range	- 0....65535 [engineering units]
Default value	- 0 [engineering units]
Comments	- Sets <i>An HiHi</i> flag used for rules processing. The reset level for this flag depends on Alarm hysteresis value.

8.2.6.2.3.10. Alarm Hi

Function	- Defines Hi alarm level in engineering units for analogue input signal.
Data type	- number
Range	- 0....65535 [engineering units]
Default value	- 0 [engineering units]
Comments	- Sets <i>An Hi</i> flag used for rules processing. The reset level for this flag depends on Alarm hysteresis value.

8.2.6.2.3.10.1. Alarm Lo

Function	- Defines Lo alarm level in engineering units for analogue input signal.
Data type	- number
Range	- 0....65535 [engineering units]
Default value	- 0 [engineering units]
Comments	- Sets <i>An Lo</i> flag used for rules processing. The reset level for this flag depends on Alarm hysteresis value.

8.2.6.2.3.11. Alarm LoLo

- Function** - Defines **LoLo** alarm level in engineering units for analogue input signal.
- Data type** - number
- Range** - 0....65535 [engineering units]
- Default value** - 0 [engineering units]
- Comments** - Sets *An LoLo* flag used for rules processing. The reset level for this flag depends on Alarm hysteresis value.

8.2.6.2.3.12. Alarm hysteresis

- Function** - Defines alarm thresholds for hysteresis value of analogue signal (in engineering units).
- Data type** - number
- Range** - 1....65535 [engineering units]
- Default value** - 10 [engineering units]
- Comments** - setting hysteresis value appropriate to signal source variations prevents overly frequent activation of alarm flags when signal source is unstable. The value declared here is also valid for alarm threshold set manually from the front panel of the module. More about meaning of Hysteresis in chapter Internal Recourses/SET buttons.

8.2.6.2.3.13. Dead band

- Function** - Defines the range of insensitivity for analogue input signal changes in engineering units
- Data type** - number
- Range** - 0....65534 [engineering units]
- Default value** - 10 [engineering units]
- Comments** - the range of insensitivity stretches symmetrically around previously noted signal value. Upon signal crosses range, new signal value is noted so that it is in mid range and a *An DB* flag is set high in binary outputs space. This flag can be used for rules processing or trigger recording in Logger .

8.2.6.3. Serial port

Sub-group serial port holds configuration parameters for PORT2.

PORT1 parameters are unchangeable (Speed: 9600, 8 bits, no parity, 1 stop bit , flow control: hardware (RTS/CTS).

8.2.6.3.1. Interface type

- Function** - defines electrical standard for serial port
- Data type** - selection list
- Range** - *RS232*
voltage interface $\pm 12V$, full duplex, three wire,

- RS422*
differential interface, full duplex, double pair,
- RS485*
differential interface, half duplex, single pair.
- Default value** - *RS232*
- Comments** - n/a

8.2.6.3.2. Transmission speed

- Function** - defines transmission speed (bits/s) for serial port
- Data type** - selection list
- Range** - *1200, 2400, 4800, 9600, 19200, 38400 [b/s]*
List of supported speeds
- Default value** - *9600 [b/sec]*
- Comments** - n/a

8.2.6.3.3. Stop bits

- Function** - defines number of stop bits
- Data type** - selection list
- Range** - *1, 2*
List of options
- Default value** - *1*
- Comments** - Function has no influence on transmission parameters for Modbus modes. Number of stop bits depends on selected parity control mode.

8.2.6.3.4. Parity

- Function** - defines control of transmitted byte
- Data type** - selection list
- Range** - *n/a (None)*
Even
Odd
List of available options
- Default value** - *n/a*
- Comments** - For operating modes for ports with MODBUS protocol, this setting has following influence on stop bits:
1 stop bit
for *Even* and *Odd*,
2 stop bits
for *n/a*.

8.2.6.4. Asynchronous clocks

Two **Asynchronous clocks** can cyclically count time for up to days (8640000 s). Counting starts immediately after module starts up and goes on until switched off. Asynchronous clocks have two Triggering outputs T1, T2, that can be used for rules processing.

8.2.6.4.1. Clocks TMR1, TMR2

8.2.6.4.1.1. Period

Function	- Defines (in seconds) asynchronous timer counting period
Data type	- number
Range	- 0...8640000 [s]
Default value	- 0 [s]
Comments	- <i>0 (zero)</i> value switches the clock off

8.2.6.5. Synchronous clocks

Synchronous clocks group contains parameters set for two clocks capable of cooperating with module real time (RTC) clock thus enabling triggering of events synchronized with defined time.

8.2.6.5.1. Clock TMR3, TMR4

8.2.6.5.1.1. Start

Function	- synchronizes timer's clock setting start point and counting period.
Data type	- time [HH:mm]
Range	- 0:00 - 23:59
Default value	- 0:00
Comments	- n/a

8.2.6.5.1.2. Period

Function	- defines synchronous clock counting period in minutes.
Data type	- number
Range	- <i>0...1440 [min]</i>
Default value	- <i>0 [min]</i>
Comments	- <i>0 (zero)</i> value switches the clock off

8.2.6.6. Logger

This section's parameters define operation of internal **Logger**, recording state changes on binary inputs/outputs and analogue inputs state. The capacity of internal buffer is 140 records. New records are written into memory after changes of state on binary inputs/outputs or at crossing of dead band for analogue inputs.

8.2.6.6.1. Active

Function	- defines Logger status
Data type	- selection list
Range	- <i>Yes</i> Logger active <i>No</i> logger inactive

- Default value** - *No*
- Comments** - During MT-101 module operation, the state of Logger may be remotely altered by *MLOG_act* bit in binary outputs space. *1* – active, *0* – inactive.
Upon start of the logger, the first record of actual state is created. Switching the Logger off triggers transmission of logger content to defined recipient but only when it holds records with data.

8.2.6.6.2. Sampling interval

- Function** - Defines (in seconds) the interval of checking module inputs state
- Data type** - number
- Range** - 0...1500 [s]
- Default value** - 0 [s]
- Comments** - *0 (zero)* value results in sampling interval of 100ms

8.2.6.6.3. Buffer flush mode

- Function** - defines Logger buffer flush mode
- Data type** - selection list
- Range** - *Auto*
Data collected in Logger are sent automatically upon filling the buffer up or after Buffer flush interval time. The logger is zeroed after transmission.
Upon request
Flushing Logger buffer is possible only by forcing
- Default value** - *Auto*
- Comments** - Flushing of Logger buffer may be remotely forced by setting *MLOG_rd bit* to *1* (one) in binary outputs space. Note that when forcing, some data may get lost if querying is too slow compared to object's dynamics. If the buffer gets filled between readings, new data will replace oldest data so the latest 140 records are preserved.

8.2.6.6.4. Buffer flush interval

- Function** - Defines (in seconds) the interval of buffer flushing in automatic mode
- Data type** - number
- Range** - 0...65535 [s]
- Default value** - 0 [s]
- Comments** - *0 (zero)* disables timed flushing. In any case, the Logger is emptied upon buffer filling. Note that in timed flushing, frames are sent only when buffer has at least 1 record.

8.2.6.6.5. Recipient IP address

Function	- defines IP address of device to send Logger buffer to.
Data type	- selection list
Range	- friendly names of IP of devices declared as Authorized to communicate with module
Default value	- IP1 - first number on the list of authorized numbers
Comments	- since IP address of recipient is selected from list of friendly names, assigning unambiguous unique descriptive names is beneficial

8.2.6.7. MT2MT Buffer

MT2MT Buffer enables creation of system where modules may exchange information (internal registers) with each other. Using buffer requires activation and defining register space where exchange is going to take place. More in chapter Internal Resources/MT2MT Buffer.

8.2.6.7.1. Active

Function	- defines state of employing MT2MT Buffer
Data type	- selection list
Range	- <i>Yes</i> MT2MT Buffer active <i>No</i> MT2MT Buffer inactive
Default value	- <i>No</i>
Comments	- n/a

8.2.6.7.2. Sending to PORT2

Function	- Defines whether received event data buffer has to be sent to PORT2
Data type	- selection list
Range	- <i>Yes</i> Received data will be sent <i>No</i> Received data will not be sent
Default value	- <i>No</i>
Comments	- This parameter has no influence on events with status that are always sent to PORT2

8.2.6.7.3. Buffer address

Function	- Defines start address of internal register space used for events reception.
Data type	- number
Range	- 0....999
Default value	- 64

Comments - received events registers laying outside defined space are not copied.

8.2.6.7.4. Buffer size

Function - Defines the size of internal registers space used for events reception.

Data type - number

Range - 1....512

Default value - 16

Comments - received events registers laying outside defined space are not copied.

8.2.6.8. Constant parameters

An option of defining Constant parameters under configuration was added for the user's convenience. Parameters are loaded to module memory during initialization of the module. More in chapter Internal Resources/Parameters.

8.2.6.8.1. Number of parameters

Function - Defines number of available constant parameters

Data type - number

Range - 0...128

Default value - 0

Comments - n/a

8.2.6.8.2. Parameter 1...128

Consecutive parameters are defined as numbers ranging from 0...65535.

8.2.7. Rules

Rules group contains lists of transmission tasks performed by internal program when criteria defined in rules are met. Tasks are divided into two groups:

- rules concerning transmission of SMS messages
- rules concerning transmission of data

In both cases, the criteria are defined by using same resources and conditions of application of the rule.

8.2.7.1. SMS sending

List of SMS sending rules can hold max. 32 entries defining short text message transmission conditions. Adding a new position is done in the context menu by right-clicking mouse while one of positions on the list is highlighted.

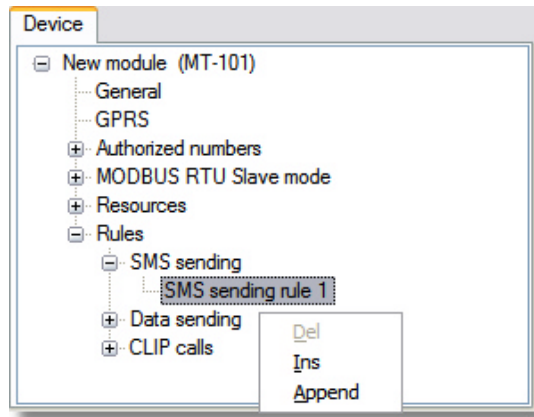

Adding more rules is done by setting the parameter number of SMS sending rules to desired value.

8.2.7.1.1. Number of SMS sending rules

Function	- declares number of SMS sending rules
Data type	- number
Range	- 1....32
Default value	- 1
Comments	- diminishing the number of rules does not delete settings until the configuration is written to the module.

8.2.7.1.2. SMS sending rule

Each of the rules residing on the list is defined by following parameters:

- Trigger input
- Trigger flag
- SMS text
- Recipient number
- Status sending

8.2.7.1.2.1. Trigger input

Function	- defines resource to observe
Data type	- selection list
Range	- <i>n/a</i> the rule is inactive <i>I1...I8</i> binary inputs <i>Q1...Q8</i> binary outputs <i>A1, A2</i> analogue inputs <i>FS1_ups, FS1_q+, FS1_gprs</i> system trigger inputs <i>P1...P32</i> user program inputs <i>TMR1, TMR2, TMR3, TMR4</i> synchronous and asynchronous clocks trigger inputs
Default value	- <i>n/a</i>
Comments	- more about trigger inputs and flags in chapter Appendices

8.2.7.1.2.2. Trigger flag

- Function** - defines event-triggering flag associated with selected trigger input
- Data type** - selection list
- Range** - *n/a*
rule inactive
Bi In 0->1, Bi In 1->0 Bi In Chg
binary input state change
Bi Out Err
discrepancy between the forcing and output state
Counter
counter flip over (up or down)
An LoLo, An Lo, An Hi, An HiHi, An Set Fall, An Set Rise An DB
alarm threshold flags for analogue inputs signals
- Default value** - *n/a*
- Comments** - more about trigger inputs and flags in chapter Appendices

8.2.7.1.2.3. SMS text

- Function** - allows entering text sent in message triggered by defined rule
- Data type** - text
- Range** - letters, numerals, special characters - max. length: 160 characters
- Default value** - .
- Comments** - if the message will include the status of the module, total length of SMS text and the status may not exceed 160 characters. If the length is greater, the text will be truncated so that full status is sent.

8.2.7.1.2.4. Recipient number

- Function** - selects message recipient number
- Data type** - selection list
- Range** - friendly names of recipients associated with phone numbers in Authorized numbers list
- Default value** - NUM 1 - first number on the list
- Comments** - since recipient's phone number is selected from the list of friendly names, it is important to enter unique, unambiguous names facilitating identification.

8.2.7.1.2.5. Sending additional information

- Function** - selects whether module status is to be attached to the message.
- Data type** - List
- Range** - *Status and timestamp*
Status and timestamp attached to SMS
Timestamp
Timestamp attached to SMS
None
Only SMS text is send
- Default value** - *Status and timestamp*

- Comments** - Total length of SMS text and additional information may not exceed 160 characters. If the length is greater, the text defined by user will be truncated so that additional information will be sent.

8.2.7.2. Data sending

List of SMS sending rules can hold max. 32 entries defining data transmission conditions. A defined data block or Status will be sent to appointed IP address. Adding a new position is done in the context menu by right-clicking mouse while one of positions on the list is highlighted.

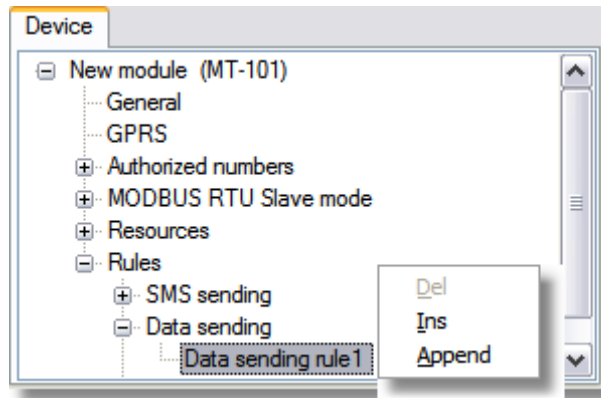

Adding more rules is done by setting the parameter number of data sending rules to desired value.

8.2.7.2.1. Number of data sending rules

- Function** - declares number of SMS sending rules
Data type - number
Range - 1....32
Default value - 1
Comments - diminishing the number of rules does not delete settings until the configuration is written to the module.

8.2.7.2.1.1. Data sending rule

Each of rules residing on the list is defined by following parameters:

- Trigger input
- Trigger flag
- IP Address
- Send
- Buffer address
- Buffer size

8.2.7.2.1.1.1. Trigger input

- Function** - defines resource to observe
Data type - selection list
Range - *n/a*
the rule is inactive

I1...I8
binary inputs
Q1...Q8
binary outputs
A1, A2
analogue inputs
FS1_ups, FS1_q+, FS1_gprs
system trigger inputs
P1...P32
user program inputs
TMR1, TMR2, TMR3, TMR4
synchronous and asynchronous clocks trigger inputs

Default value - *n/a*
Comments - more about trigger inputs and flags in chapter Appendices

8.2.7.2.1.1.2. Trigger flag

Function - defines event triggering flag associated with selected trigger input
Data type - selection list
Range - *n/a*
rule inactive
Bi In 0->1, Bi In 1->0 Bi In Chg
binary input state change
Bi Out Err
discrepancy between the forcing and output state
Counter
counter flip over (up or down)
An LoLo, An Lo, An Hi, An HiHi, An Set Fall, An Set Rise An DB
alarm threshold flags for analogue inputs signals
Default value - *n/a*
Comments - more about trigger inputs and flags in chapter Appendices

8.2.7.2.1.1.3. IP address

Function - selects recipient's IP address
Data type - selection list
Range - friendly names of recipients associated with IP addresses in Authorized numbers list
Default value - IP1 - first number on the list
Comments - since recipient's IP address is selected from the list of friendly names, it is important to enter unique, unambiguous names facilitating identification.

8.2.7.2.1.1.4. Send

Function - defines data type sent in transmission triggered by defined rule
Data type - List
Range - *Status*
Module Status will be sent

Buffer Hold. Reg.

Registers from modules' internal registers' space will be sent. Defining the transmitted space is required.

Buffer Inp. Reg.

Registers from module input registers' space will be sent. Defining the transmitted space is required.

Default value - *Status*

Comments - n/a

8.2.7.2.1.1.5. Buffer address

Function - Defines start address of internal registers space sent in transmission triggered by defined rule

Data type - number

Range - 0...8191

Default value - 64

Comments - n/a

8.2.7.2.1.1.6. Buffer size

Function - Defines size of internal registers space sent in transmission triggered by defined rule

Data type - number

Range - 1...700

Default value - 16

Comments - n/a

8.2.7.3. CLIP calls

CAUTION!
This option is not supported starting with v 1.42 of the MT-101 module's firmware.
The description is solely to support the legacy firmware.

The term „CLIP call“ describes attempts to establish a phone connection to a defined number.

This connection is not supposed to be picked up by the recipient. Identification of sending module's phone number is enough to convey the alert. The meaning of alert should be agreed upon. Notice that recipient does not have to be a GSM network subscriber but must have a phone able to identify and display caller ID.

The function corresponds to sending 1 bit of information triggered by event occurrence free of charge.

The list of rules holds max. 32 rules allowing to establish a connection with selected phone number.

Adding a new position is done in the context menu by right-clicking mouse while one of positions on the list is highlighted.

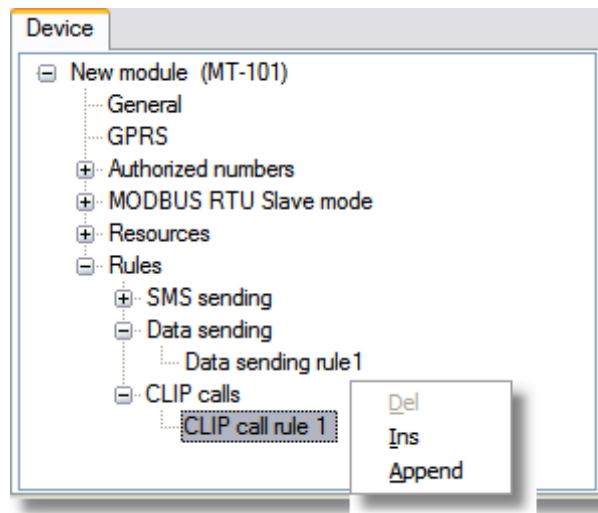

Adding more rules is done by setting the parameter number of SMS sending rules to desired value.

8.2.7.3.1. Number of CLIP calls rules

Function	- declares number of CLIP calls rules
Data type	- number
Range	- 1....32
Default value	- 1
Comments	- diminishing the number of rules does not delete settings until the configuration is written to the module.

8.2.7.3.2. Number of trials

Function	- defines number of consecutive retries if the called number is busy or unavailable
Data type	- number
Range	- 0....255
Default value	- 3
Comments	- <i>0 (zero)</i> value results with no redial attempts.

8.2.7.3.3. Interval between trials

Function	- defines (in seconds) interval between consecutive redial attempts
Data type	- number
Range	- 0....255 [s]
Default value	- 20 [s]
Comments	- <i>0 (zero)</i> value results in an immediate redial

8.2.7.3.4. CLIP call rule

Each of rules residing on the list is defined by following parameters:

- Trigger input
- Trigger flag
- Recipient number
- Calling time

8.2.7.3.4.1. Trigger input

Function	- defines resource to observe
Data type	- selection list
Range	- <i>n/a</i> the rule is inactive <i>I1...I8</i> binary inputs <i>Q1...Q8</i> binary outputs <i>A1, A2</i> analogue inputs <i>FS1_ups, FS1_q+, FS1_gprs</i> system trigger inputs <i>P1...P32</i> user program inputs <i>TMR1, TMR2, TMR3, TMR4</i> synchronous and asynchronous clocks trigger inputs
Default value	- <i>n/a</i>
Comments	- more about trigger inputs and flags in chapter Appendices

8.2.7.3.4.2. Trigger flag

Function	- defines event triggering flag associated with selected trigger
Data type	- selection list
Range	- <i>n/a</i> rule inactive <i>Bi In 0->1, Bi In 1->0 Bi In Chg</i> binary input state change <i>Bi Out Err</i> discrepancy between the forcing and output state <i>Counter</i> counter flip over (up or down) <i>An LoLo, An Lo, An Hi, An HiHi, An Set Fall, An Set Rise An DB</i> alarm threshold flags for analogue inputs signals
Default value	- <i>n/a</i>
Comments	- more about trigger inputs and flags in chapter Appendices

8.2.7.3.4.3. Recipient number

Function	- selects CLIP call recipient number
Data type	- selection list
Range	- friendly recipient names associated with phone numbers in Authorized numbers list

- Default value** - NUM 1 - first number on the list
- Comments** - since recipient's phone number is selected from the list of friendly names, it is important to enter unique, unambiguous names facilitating identification.

8.2.7.3.4.4. Calling time

- Function** - Gives an option to attach verbose device status to SMS message
- Data type** - List
- Range** - *Auto*
 Option used when GSM operator supports feedback on proper identification of caller ID by receiving caller's terminal.
5, 10, 20, 30 [s]
 Options used when GSM operator does not support feedback on proper identification of caller ID. Defined in Recipient number parameter.
- Default value** - *Auto*
- Comments** - n/a

8.3. Configuration writing

After required modifications and parameter settings, the configuration is stored on the configuring PC's hard disk only. In order to write it to the module memory, it has to be transmitted to the module.

The method of transmission depends on whether we configure it locally or remotely via GPRS. For local configuration, it is enough to secure a connection via RS232 cable. Detailed description of local configuration is to be found in the MTM user manual.

For remote configuration, it is vital that the computer running the configuration application has access to the APN where the configured module resides. Detailed description of remote configuration is to be found in the MTM user manual.

8.4. Verification of configuration

Despite high reliability of both local and remote module configuration, verify of it is important.

It is relevant if the module's behavior does not comply in accordance with the performed configuration.

For verification, please read the configuration from the module and check parameters settings.

Reading of module configuration is described in details in MTM users manual.

9. Programming

9.1. General information

Modules from the MT-10x and MT-202 series and EX-101 expansion allow downloading user-defined internal programs, thereby expanding module functionality with non-standard algorithms of data processing and module control. Programming is accomplished by using

the **MTProg** application delivered free of charge to our customers, giving them the possibility of programming in integrated environments.

Basic information regarding user programs functionality:

- The program is executed cyclically every 100ms.
- If the particular program cycle does not complete execution within 100ms, the next cycle will not start immediately but at the next 100ms round. The omission of the program cycle is signaled by flashing of OVR LED. In such cases, the user program should use RTC register values or clock blocks instead of measuring the time by incrementing a register value for each cycle.
- The user program can consist of max. 1024 instructions.
- Max. number of instructions carried out in one cycle is limited to 2000. Upon reaching this value, the program is automatically disrupted and restarted at the next 100ms round.
- The program is capable of carrying approx. 750 instructions in 100ms.
- The function of copying the buffers copies approx. 1500 registers in 100ms.
- The function of fast copying of blocks copies approx. 7000 registers in 100ms.

9.2. Starting to work

It is recommended to set up the working environment during the first run of the program.

For this purpose, select menu item Help/Settings or activate  icon from the Toolbar and the following dialog window will appear. Fill in the relevant data for parameters.

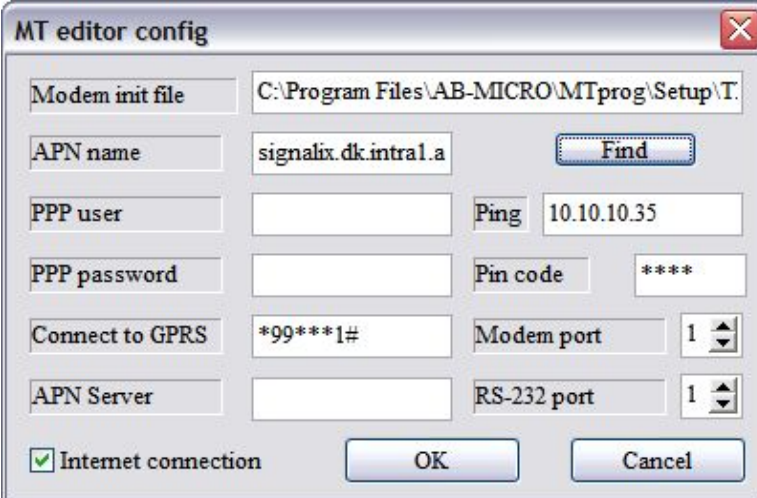

Modem init file

Finds and selects the file holding initialization parameters for the GPRS modem used to communicate with remote module.

APN name

States name of the APN where programmed module resides.

PPP user

Parameter has to be defined only if network operator requires it.

PPP password

Parameter has to be defined only if network operator requires it.

Connect to GPRS

Parameter has to be defined only if network operator requires it.

APN server

IP address of the computer routing data packets sent via internet.

Internet connection

When selected in conjunction with "RS-232 port", it sets up the communication via dial up GPRS connection or via routed Ethernet connection.

This is the optimal way of communication between MTProg and remote modules.

When unselected, it leaves the connection to GPRS modem and MTProg takes care of initializing modem and establishing connection.

Ping

IP address pinged by application in order to maintain internet connection session. This address must belong to the same APN as programmed module. (Can be the programmed module's IP). If used, leave it at default „0.0.0.0“.

PIN code

Contains PIN code of the SIM card placed in the modem employed to communicate with APN.

Modem port

Contains number of the com port the GPRS modem is connected to.

RS-232 Port

Contains number of the com port the programmed module is connected to via serial cable.

Select the chosen module and connection type. In order to do so activate parameter

„Select“ from menu „Module“ or click the icon  on the toolbar. The selection window will open and present all available options.

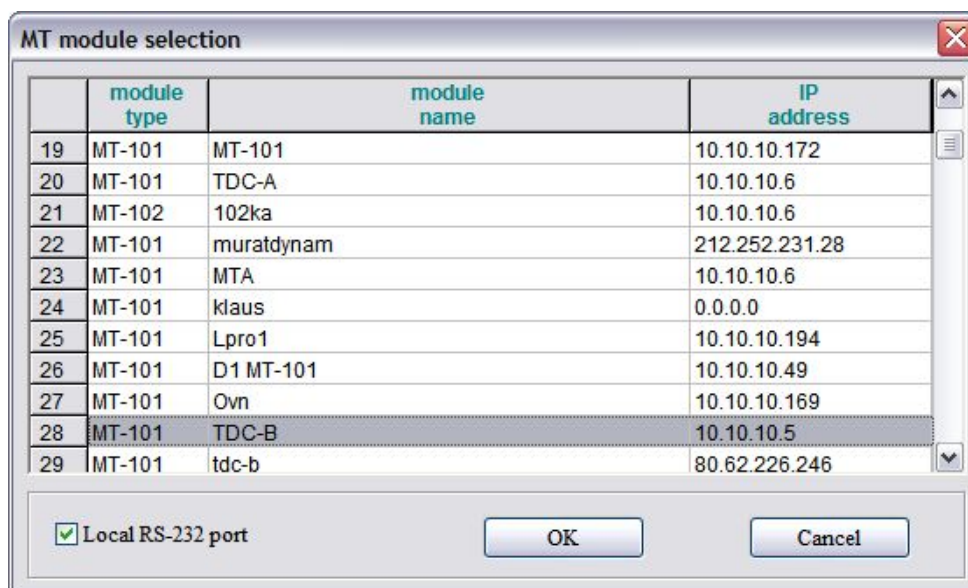

Notice that only modules defined and configured by MTManager application in active Project are selectable.

When Local port RS 232 is checked in, serial transmission via RS 232 takes place. When Local port RS 232 is unchecked, GPRS transmission is employed and module IP address is used.

„OK“ button stores the choice for connecting MTprog.exe application with selected module and opens program editing table.

9.3. Main window layout

Main program window displays a table containing the program to be executed by module's command interpreter. Right side of the window contains a field with button groups dedicated to defining operations and constants. On top, there is a system menu and a toolbar with icons for frequently used functions. At the bottom, a status bar displays from the left: status of command interpreter, selected module's name and selected communication channel.

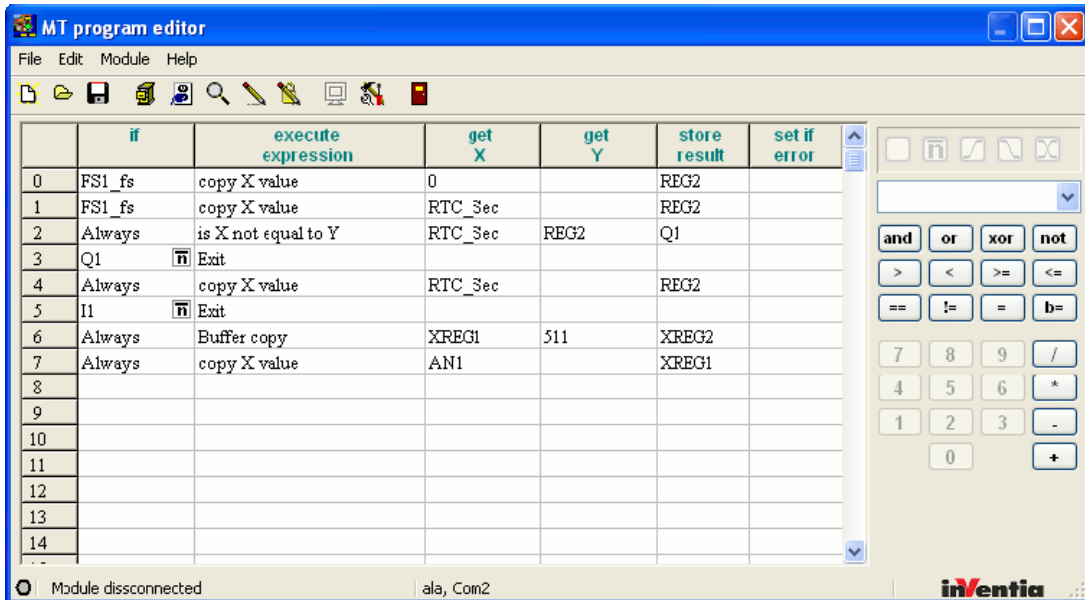

9.3.1. Menu items

9.3.1.1. File

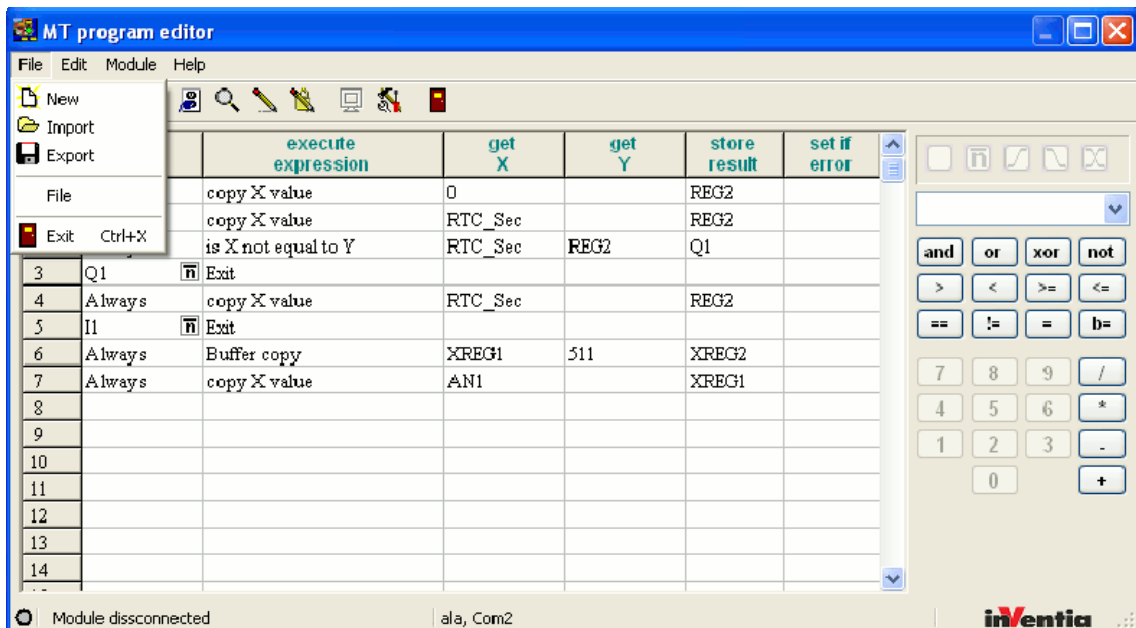

Function "New"

Erases the program visible in the table and the table is ready for editing of a new program.

The icon  on the toolbar performs same function.

Function "Import"

Writes a program previously stored on the hard disc into the table. Programs have a default extension ".MTP".

The icon  on the toolbar performs same function.

Function "Export"

Stores the program from the table on the hard disc with default extension ".MTP".

The icon  on the toolbar performs same function.

Function "File"

Stores the program from the table on the hard disc in clear text, creating good documentation.

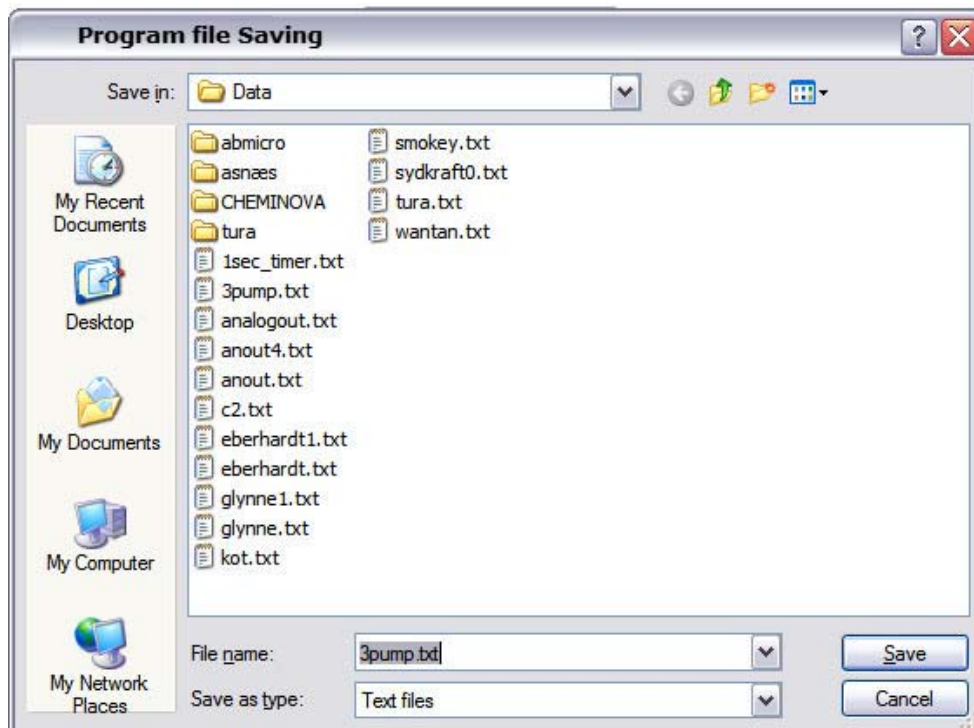

Function "Exit"

Closes the application after confirmation. The keyboard shortcut for this function is "Ctrl-X".

The icon  on the toolbar performs same function.

9.3.1.2. Edit

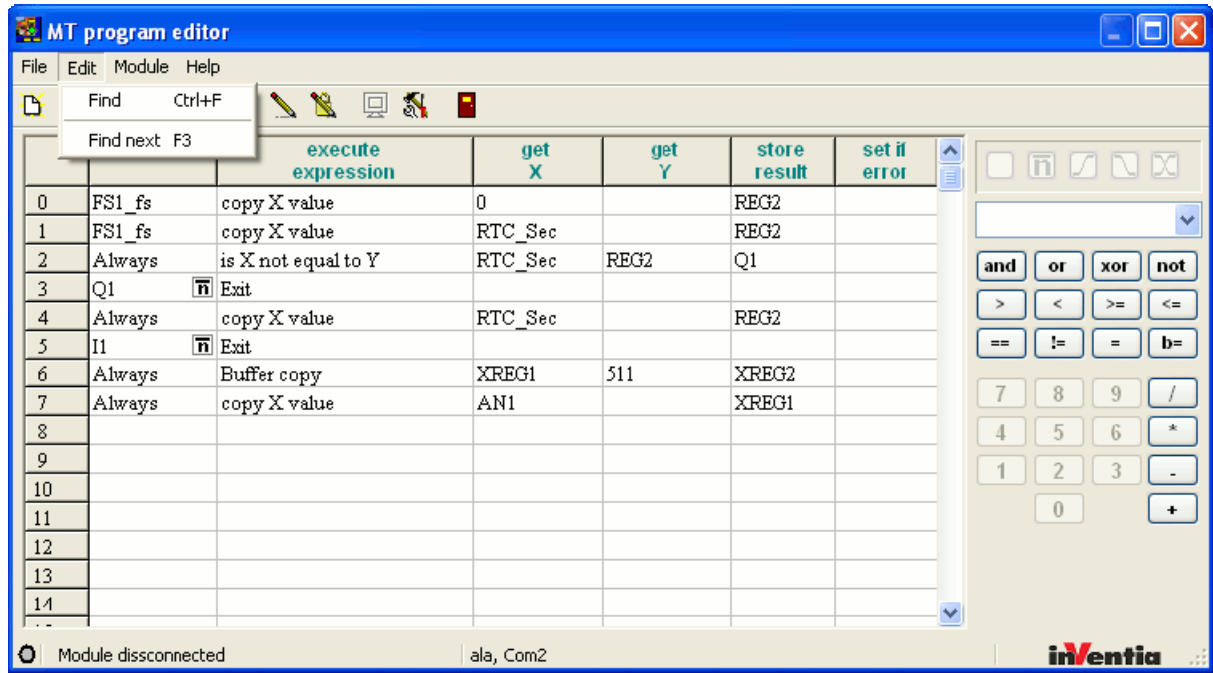

- **Function "Find"**

Allows searching the program for defined text (eg. register name). Text that you want to look for is entered in the window opened just after clicking this menu position. It is possible to choose if the search phrase is case sensitive and if search phrase is a complete "word" or only part of it (whole contents only). After selecting OK cursor in main window will move to first cell with found search phrase.

Search area begins from first cell after selected and ends where program ends.

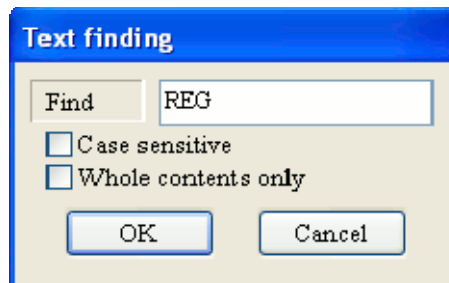

Function can also be started by using keyboard shortcut **Ctrl+F**.

- **Function "Find next"**

Moves cursor to next cell with searched phrase.

Function can also be started by using keyboard shortcut **F3**.

9.3.1.3. Module

Module Menu consists of functions governing the state of programmed module. Functions of this menu item change dynamically depending on the state of connection with the module and the state of the module's internal program.

Active functions of the menu when program is disconnected from the module....

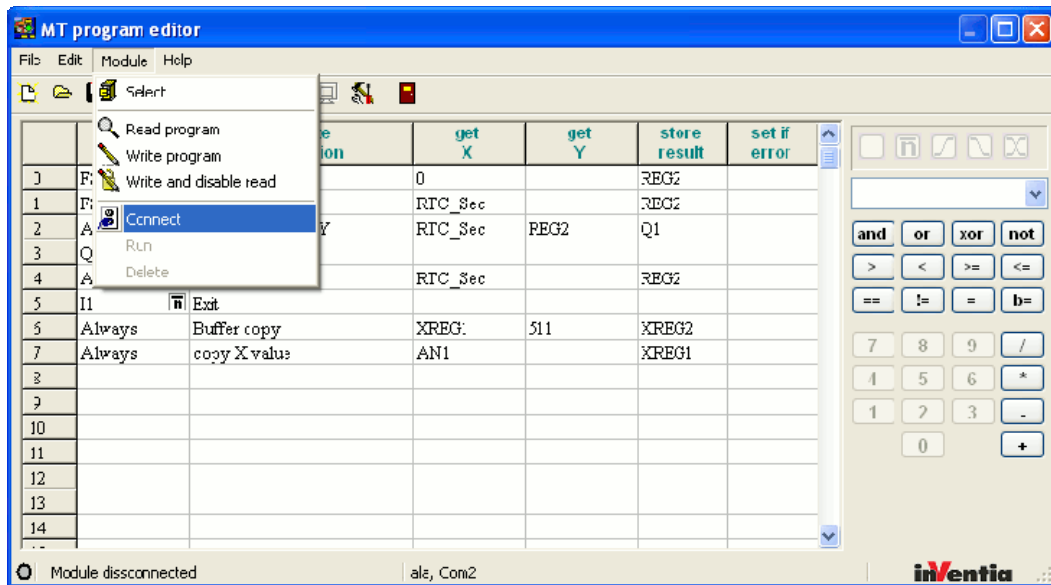

and after connecting to the module with internal program running. Notice the green dot in lower left corner of the status bar.

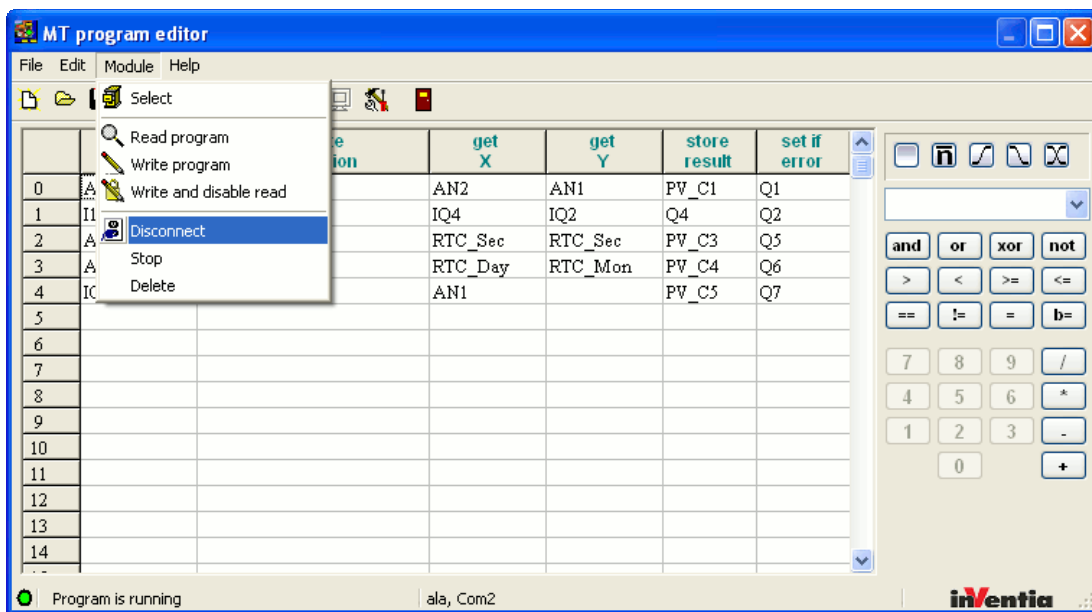

Function "Select"

Presents the list of defined modules for selection of the desired module. The list has the option of selecting transmission mode via either RS232 cable or wireless (GPRS) connection using the module's IP address.

	module type	module name	IP address
19	MT-101	MT-101	10.10.10.172
20	MT-101	TDC-A	10.10.10.6
21	MT-102	102ka	10.10.10.6
22	MT-101	muratdynam	212.252.231.28
23	MT-101	MTA	10.10.10.6
24	MT-101	klaus	0.0.0.0
25	MT-101	Lpro1	10.10.10.194
26	MT-101	D1 MT-101	10.10.10.49
27	MT-101	Ovn	10.10.10.169
28	MT-101	TDC-B	10.10.10.5
29	MT-101	tdc-b	80.62.226.246

Local RS-232 port

OK Cancel

The table shows data written in system registers by MTManager application. MTProg application can only access modules previously defined and configured in active Project by MTManager.

The icon  on the toolbar performs same function.

Function "Read program"

Reads the content of module's program interpreter into the table.

If the application is connected to the module, the control in the left side of the status bar is lit in red or green depending on the state of the program interpreter. The text displayed close to the control reflects the actual state and the function "Read program" is active.

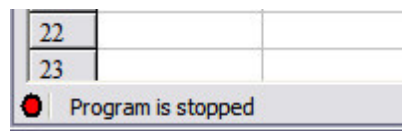
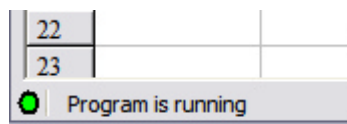

If the connection is not established or broken the control is gray and reading from the module is impossible.

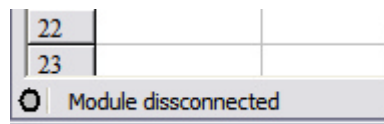

In case of serial cable connection the queries about sequential program lines are sent. Lines are continuously read and displayed in the table. In GPRS mode there is a couple of seconds delay between the query and response arrival. In order to speed the function up queries are sent without waiting for response. Upon arrival of response the value is displayed in the table.

The icon  on the toolbar performs same function.

Function "Writing to module"

This function writes the program from the table to the module. If the table is empty, the effect of using this function will be erasing a program existing in the module.

All introductory remarks concerning the connection and password protection of Read function are valid in this case as well. The process of writing program into module's interpreter is similar. The only difference appears in GPRS mode. After verification of privileges all lines of program are sent and the application waits for confirmations.

The icon  on the toolbar performs same function.

Function "Write and disable read"

This function writes the program from the table into the module disabling the reading function. The only way of modifying the program in the module is to write it again or import previously stored programs and modify it.

The icon  on the toolbar performs same function.

Function "Connect"

This function toggles between ON-Line and OFF-Line mode.

In first case, MTprog.exe application sends cyclically queries about module's interpreter state and on the base of received response displays status information in lower left corner of main window. The menu item Help/Transmission opens transmission window displaying sent commands and replies.

ON-Line/OFF-Line differentiation is important during connection via modem in GPRS mode. Leaving the application connected with the module for longer time results in higher costs of transmission since transfer may be roughly estimated to 2 kB per minute.

In ON-Line mode, the serial port connecting the computer with the module or GPRS modem is occupied by MTprog.exe application and cannot be used by other applications. In OFF-Line mode, serial port is released and may be used by any other application.

The icon  on the toolbar performs same function.

Function "Start"

This function starts the command interpreter of the module.

To start the interpreter the module has to be in ON-Line mode. This function does not have a corresponding icon on the toolbar.

Function "Delete"

This function deletes data from the module's data memory space.

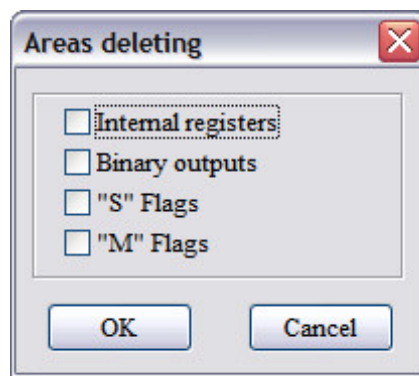

The selected for deletion areas should be checked in. Pressing the OK button resets selected areas.

9.3.1.4. Help

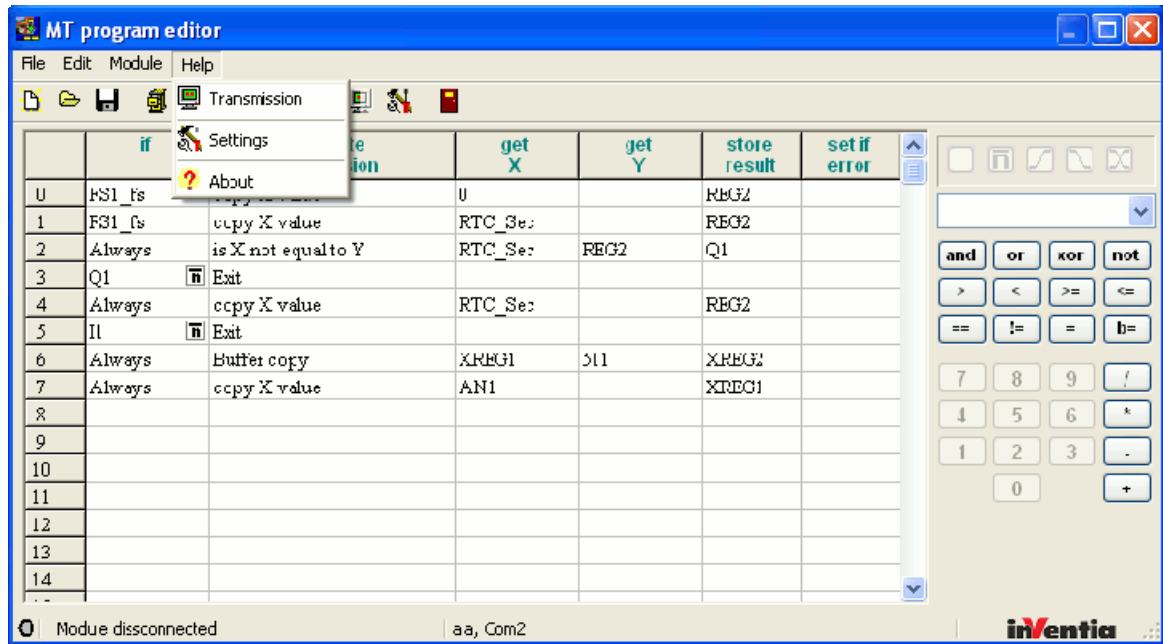

Function "Transmission"

toggles transmission review window

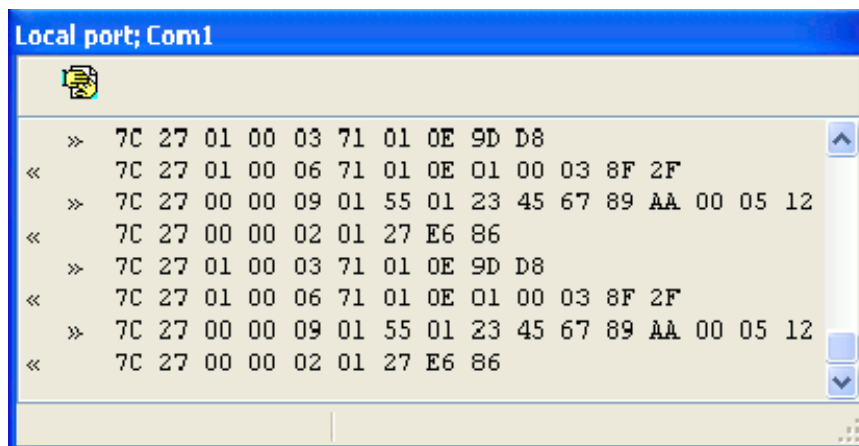

The title bar displays transmission type and recipient address while status bar displays connection status. The tool bar displays the icon closing the window.

The main window's tool bar icon  toggles transmission window display.

Function "Settings"

opens environment configuration window described in "Starting to work" section.











The icon  on the toolbar performs same function

Function "About"

opens window displaying version number and Manufacturer's address data.

9.3.1.5. Toolbar

The main window's toolbar holds icons corresponding to following menu functions:

	menu item "File"	Function "New"
	menu item "File"	Function "Red"
	menu item "File"	Function "Write"
	menu item "Module"	Function "Select"
	menu item "Module"	Function "Connect/Disconnect"
	menu item "Module"	Function "Read program"
	menu item "Module"	Function "Write program"
	menu item "Module"	Function "Write and block reading"
	menu item "Help"	Function "Transmission"
	menu item "Help"	Function "Settings"
	menu item "File"	Function "Exit"

9.4. Program editor table

The table has six columns. Each column has specific role assigned to be performed by the command interpreter:

	if	execute expression	get X	get Y	store result	set if error
0						
1						
2						
3						
4						
5						
6						
7						
8						
9						
10						
11						

"If" – defines the condition for the table row to be executed. If not met, the line will be skipped.

"Execute expression" – defines the function to be performed,

"Get X" - holds the first argument of interpreted function,

"Get Y" - holds the second argument of interpreted function,

"Store Result" - points to where to store the result of the function,

"Set if error" - holds the optional flag to be set if the function fails due to e.g. division by zero or overflow.

9.5. Standard functions

Most commonly used functions are grouped with numeric keyboard on the right side of the main window.

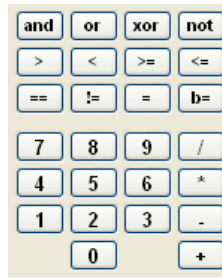

Top button row groups 4 logical operations of true/false type.



Next group represents 6 functions comparing arithmetical values.

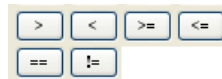

Next 2 buttons represent assignment of arithmetical and logical values.



Right column of numerical keyboard represent 4 standard arithmetical operations.



9.6. Numeric keyboard

Numerical keyboard has all keys active only when selected function allows arithmetic input.

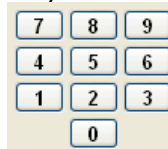

If selected function allows only logical input only keys "0" and "1" meaning respectively False/Never and True/Always.

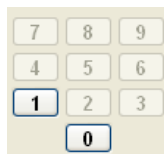

When selected function does not allow numerical input the keyboard is grayed out (inactive).



9.7. Auxiliary functions

Some modules types and versions may implement auxiliary functions. Access to these functions is possible via the drop-down menu just above numerical keyboard:

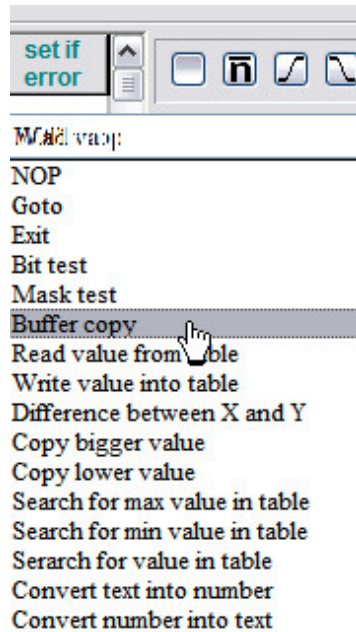

Detailed description of standard and auxiliary functions is located at chapter Description of program functions

9.8. Description of Program functions

Boolean AND X , Y

get X (bit)	get Y (bit)	store result (bit)
0	0	0
0	1	0
1	0	0
1	1	1

Boolean OR X , Y

get X (bit)	get Y (bit)	store result (bit)
0	0	0
0	1	1
1	0	1
1	1	1

Boolean XOR X , Y

get X (bit)	get Y (bit)	store result (bit)
0	0	0
0	1	1
1	0	1
1	1	0

Boolean NOT X

get X (bit)	get Y	store result (bit)
0	n.a	1
1	n.a	0

Is X greater than Y

get X (register)	get Y (register)	store result (bit)
get X > get Y		1
get X <= get Y		0

Is X lower than Y

get X (register)	get Y (register)	store result (bit)
get X < get Y		1
get X >= get Y		0

Is X greater or equal Y

get X (register)	get Y (register)	store result (bit)
get X >= get Y		1
get X < get Y		0

Is X lower or equal Y

get X (register)	get Y (register)	store result (bit)
get X <= get Y		1
get X > get Y		0

Is X equal Y

get X (register)	get Y (register)	store result (bit)
get X equal get Y		1
get X not equal get Y		0

Is X not equal Y

get X (register)	get Y (register)	store result (bit)
get X not equal get Y		1
get X equal get Y		0

Copy X value

store result (register) = get X (register)

Copy Boolean X

store result (bit) = get X (bit)

NOTICE!!!

When copying register DREG to a 16 bit register the function returns an error, since the copied value is not in the range of 0-65535.

Divide X by Y

store result (register) = get X (register) / get Y (register)

NOTICE !!!

The function operates on integers. The result is truncated to integer. Crossing the valid range sets an error flag.

Examples:

$$10 / 3 = 3$$

$$-15 / 4 = -3$$

Multiply X by Y

store result (register) = get X (register) * get Y (register)
Crossing the valid range sets an error flag.

Subtract Y from X

store result (register) = get X (register) - get Y (register)
Crossing the valid range sets an error flag.

Add X to Y

store result (register) = get X (register) + get Y (register)
Crossing the valid range sets an error flag.

Modulo

The function assigns the modulus of the division of X by Y. For proper functioning, it is required that get X >= 0 and get Y > 0. When any of preconditions are not met, the function returns an error which sets an error flag.

Examples:

$$10 / 3 = 1$$

$$-15 / 4 = \text{error}$$

$$15 / 5 = 0$$

Negation

store result (register) = -get X (register)

CAUTION!!!

Note that all registers store unsigned values. Only DREG registers can hold 32 bit signed values. Using this function on DREG registers in will in most cases return an error.

Bitwise OR

The function calculates logical sum of corresponding bits in 2 registers.

Example:

	decimal	hexadecimal	binary
get X (register)	= 1234	= 04D2	= 0000 0100 1101 0010
get Y (register)	= 4991	= 137F	= 0001 0011 0111 1111
store result (register)	= 6143	= 17FF	= 0001 0111 1111 1111

Bitwise AND

The function calculates the product of corresponding bits in 2 registers.

Example:

	decimal	hexadecimal	binary
get X (register)	= 1234	= 04D2	= 0000 0100 1101 0010
get Y (register)	= 4991	= 137F	= 0001 0011 0111 1111
store result (register)	= 82	= 0052	= 0000 0000 0101 0010

Bitwise XOR

The function calculates symmetrical difference of corresponding bits in 2 registers.

Example:

	decimal	hexadecimal	binary
get X (register)	= 1234	= 04D2	= 0000 0100 1101 0010
get Y (register)	= 4991	= 137F	= 0001 0011 0111 1111
store result (register)	= 6061	= 17AD	= 0001 0111 1010 1101

Bitwise NOT

The function negates bits in the register.

Example:

	decimal	hexadecimal	binary
get X (register)	= 1234	= 04D2	= 0000 0100 1101 0010
store result (register)	= 64301	= FB2D	= 1111 1011 0010 1101

Bit copy

The function copies selected bits from a register (get X) to register (store result). Only bits from positions where there are values of 1 in register (get Y). Other bits remain intact.

Example:

	decimal	hexadecimal	binary
get X (register)	= 1039	= 040F	= 0000 0100 0000 1111
get Y (register)	= 4915	= 1333	= 0001 0011 0011 0011
store result (register before operation)	= 3925	= 0F55	= 0000 1111 0101 0101
store result (register after operation)	= 3143	= 0C47	= 0000 1100 0100 0111

This function is very handy when copying values between register space and bit addressed memory space. Virtual registers from bit addressed memory spaces (VREG_BIx - binary inputs, and VREG_BO - binary outputs) enable access from functions operating on registers to bit variables. Virtual register mapping is sequential: first register holds first 16 bits, the next following 16 and so on...

For example:

Register	bit 0	bit 1	bit 2	bit 3	bit 4	bit 5	bit 6	bit 7	bit 8	bit 9	bit 10	bit 11	bit 12	bit 13	bit 14	bit 15
VREG_I	IQ1	IQ2	IQ3	IQ4	IQ5	IQ6	IQ7	IQ8	--	--	--	--	--	--	--	--
VREG_Q	Q1	Q2	Q3	Q4	Q5	Q6	Q7	Q8	P1	P2	P3	P4	P5	P6	P7	P8
VREG_P	P9	P10	P11	P12	P13	P14	P15	P16	CLK_C1	CLK_C2	CLK_C3	CLK_C4	CLK_C5	CLK_C6	CLK_C7	CLK_C

NOP

No operation performed.

Goto

The function jumps to specified in parameter (get X) location (program line).

CAUTION!!!

The number of instructions carried out in one program cycle is limited to 2000. Upon reaching limit, the execution stops. Next cycle starts from line number 0. Reaching the limit is signaled by ERR LED for diagnostic purposes.

Exit

The function ends the program execution for a particular cycle.

Bit test

This function verifies whether at least one bit in get X register is set according to mask defined by get Y register. If confirmed, the function returns value 1 in store result column, else 0.

Example:

	hexadecimal	binary
get X (register)	04D2	= 0000 0100 1101 0010 (value)
get Y (register)	1820	= 0001 1000 0010 0000 (mask)
store result (bit)	0	= 0
get X (register)	04F2	= 0000 0100 1111 0010 (value)
get Y (register)	1820	= 0001 1000 0010 0000 (mask)
store result (bit)	1	= 1

Mask test

This function verifies whether all bits in get X register defined in mask get Y are set. If confirmed, the function returns value 1 in store result column, else 0.

Example:

	hexadecimal	binary
get X (register)	04D2	= 0000 0100 1101 0010 (value)
get Y (register)	1820	= 0001 1000 1110 0010 (mask)
store result (bit)	0	= 0
get X (register)	04F2	= 0001 1100 1111 0010 (value)
get Y (register)	1820	= 0001 1000 1110 0010 (mask)
store result (bit)	1	= 1

Buffer copy

This function copies value of source buffer starting at register (get X) to destination buffer defined in store result. The length of copied buffer depends on the value in (get Y) register. The function stops when:

- buffer length value is negative,
- writing attempted beyond the buffer space,
- copied value exceeds allowed value of destination buffer. (For instance, an attempt to copy -1 from 32 bit register to 16 bit register).

Example:

get X (register)	= XREG10
get Y (register)	= REG1
store result (register)	= DREG2

If REG1 = 4, to function copies 4 values:

DREG5 = XREG13,
DREG4 = XREG12,
DREG3 = XREG11,
DREG2 = XREG10

CAUTION!!!

The function starts copying from the last buffer register and ends at the first register. It creates an easy way to create a logger keeping the history of selected resources in internal registers. In section "Examples of programs" a „Logger program“ illustrates using this function.

Copy block quickly

The function copies data among blocks in internal registers space. Following parameters are used:

register (get X) - source block address
register (get Y) - block size
register (store result) - destination block address

Destination and source block may overlap.

When block size exceeds the size of internal register space the data is not copied and the function rises an error flag.

Example:

REG1 = 0x60, REG2 = 0x100, REG3 = 0x600

get X (register) = REG1
get Y (register) = REG2
store result (register) = REG3

The function copies data from source block 0x060...0x15F (XREG1...XREG256) to destination block 0x600...0x6FF (P2SND_B1...P2SND_B256)

Read value from table

This function takes the numerical value from table starting with (get X) register. The value from table cell defined by index register (get Y) is copied to store result register. Table cells are indexed from 0.

store result = get X [get Y].

The function rises error flag when copied value exceeds the range of destination register or cell address lays beyond the space.

Example:

get X (register) = XREG10
get Y (register) = REG1
store result (register) = DREG2

If REG1 = 4, than function performs the operation:
DREG2 = XREG14

Write value to table

The function writes numeric value to table starting with register (store result). The value from register (get X) is copied to table cell defined by index register (get Y). Table cells are indexed from 0.

store result [get Y] = get X.

The function rises error flag when copied value exceeds the range of destination register or cell address lays beyond the space.

Example:

get X (register) = REG2
get Y (register) = DREG1
store result (register) = XREG100

If DREG1 = -5, than function performs the operation:
XREG95 = REG2

Difference between X and Y

This function calculates the integer difference between X and Y, no matter which value is higher.

Exceeding the valid range rises the error flag.

store result (register) = integer value of (get X (register) - get Y (register))

Copy bigger value

The function verifies which value, X or Y is higher and copies the higher one.

If get X > get Y than store result = get X
If get X <= get Y than store result = get Y

Copy lower value

The function verifies which value, X or Y is lower and copies the lower one.

If get X < get Y than store result = get X
If get X >= get Y than store result = get Y

Search for max value in table

The function scans the table beginning with register (get X) for length defined by register (get Y). The highest value found in search is written to (store result) register.

Both 16 and 32 bit registers can be searched. If the value found exceeds the range of (store result) register, the error flag is set.

Example 1:

Table from XREG1 = 1, 5, 0, 100, 23, 340, 1, 25, 340, 5, 560, 23

get X (register) = XREG1
get Y (register) = 10
store result (register) = REG1

The result is REG1 = 340

Example 2:

Table from DREG1 = 1, 5, 0, -12000, 23, 340, 1, 25, 340, 5, 65000, 23, 100000, -65000

get X (register) = DREG1
get Y (register) = 12
store result (register) = REG1

The result is REG1 = 65000.

If register had the value of 13 for (get Y), the function would have returned REG1 value equal to 100000.

Search for min. value in table

The function scans the table beginning with register (get X) for length defined by register (get Y). The lowest value found in the search is written to (store result) register.

Both 16 and 32 bit registers can be searched. If the value found exceeds the range of (store result) register, the error flag is set.

Example 1:

Table from XREG1 = 1, 5, 6, 100, 23, 340, 1, 25, 340, 5, 560, 0

get X (register) = XREG1
get Y (register) = 10
store result (register) = REG1

The result is REG1 = 1

Example 2:

Table from DREG1 = 1, 5, 0, -12000, 23, 340

get X (register) = DREG1
get Y (register) = 4
store result (register) = REG1

The result is since REG1 cannot hold the value of -12000.

Search for value in table

The function scans the table (buffer) starting with register (get X) searching for value defined in (get Y) register. The table is searched for first occurrence of searched value or to the end of the memory space. If the value is found, the function returns an index to the register. Indices are calculated from 0. If not found, the function sets an error flag.

NOTICE!!!

The function can search tables of 32 bit registers though one has to be aware that index returned is a 32 table index and not equal to the offset in the address space, as is the case for 16 bit tables.

Example 1:

Table from XREG1 = 1, 5, 0, 100, 23, 340, 1, 100, 340, 5, 560, 23

get X (register) = XREG1
get Y (register) = 100
store result (register) = REG1

The result is REG1 = 3

Example 2:

Table from DREG1 = 1, 5, 0, -12000, 23, 340, 1, -100

get X (register) = DREG2
get Y (register) = DREG1
store result (register) = REG1

The result is REG1 = 5

Convert text to number

The function converts decimal value from text to binary. Get X defines start of the text buffer to convert. Text characters are written to low order bytes of 16 bit registers. Get Y defines max number of characters (registers) to convert. The function after successful conversion writes the result in (store result) register. The result is always an integer value. If converted value had a decimal fraction, the decimal separator is omitted and function writes the number of digits after comma to AUX_RET2 register. This allows handling of scaled floating point values. Recognized delimiters are '.' and ','. Furthermore, the function writes the length of converted value. The converted value may be a negative number provided that result storing register is a 32 bit register.

Examples:

get X	get	store result		AUX_RET1	AUX_RET2
		REG1	DREG1		
0abc	4	0	0	1	0
0.000abc	8	0	0	5	3
1234.56789	3	123	123	3	0
-1234.56789	7	Error	-12345	7	1
+0.1234abc	10	1234	1234	7	4
abc	3	Error - number format			
1234.5678900	12	Error - value too big			
1234.56	7	Error	123456	7	2
0,00000012	10	12	12	10	8
.123	4	Error - number format			

123.456.789.000	15	Error	123456	7	3
+000111.2	9	1112	1112	9	1
12.0000	7	Error	120000	7	4
12.0000	6	12000	12000	6	3

Convert number to text

This function converts a binary value from register (get X) to text. The result is written into buffer starting with (store result) register. Separate text characters are stored in low order bytes of 16 bit registers. Get Y defines converted number's format.

get Y:

- unit number defines the number of digits after comma in resultant format.
- tens number defines number of digits before comma , 0 – automatically
- + 100 – sets delimiter to ',' instead of '.'
- + 200 – forces adding a sign before positive value.

Furthermore, the function writes the resultant number's length in characters to AUX_RET1 register.

If the converted number is larger then allowed range, the function does not perform the conversion and raises an error flag.

Examples:

get X	get Y	store result	AUX_RET1
0	0	0	1
123	0	123	3
-1234	0	-1234	5
12345	2	123.45	6
123456	103	123,456	7
123456	23	Error	---
0	323	+00,000	7
-15	323	-00,015	7
-15	50	-00015	6

Logical shift left

Function shifts left bits in argument X. Number positions to shifts is defined by parameter Y. The bits that are shifted out are discarded, and zeros are shifted in. Get Y should be ≥ 0 , otherwise operation will not be completed and error bit will be set. Error bit will be set also when bit set high (1) will be shifted out.

Examples:

get X	get Y	store result	set if error
0x0000	1	0x0000	0
0x1234	-2	undefined	1
0x0001	15	0x8000	0
0x0003	15	REG=0x8000	1
0x0003	15	DREG=0x00018000	0
0x0003	31	REG=0x0000	1
0x0003	31	DREG=0x80000000	1
0x0001	≥ 32	0x0000	1

0x0000	≥32	0x0000	0
0x00010000	0	DREG=0x00010000	0
0x00010000	0	REG=0x0000	1

Logical shift right

Function shifts right bits in argument X. Number positions to shifts is defined by parameter Y. The bits that are shifted out are discarded, and zeros are shifted in. Get Y should be ≥ 0, otherwise operation will not be completed and error bit will be set. Error bit will be set also when bit set high (1) will be shifted out.

Examples:

get X	get Y	store result	set if error
0x0000	1	0x0000	0
0x1234	-2	undefined	1
0x1112	1	0x0889	0
0x1111	1	0x0888	1
0x01118000	15	0x0223	0
0x81118000	15	REG=0x0223	1
0x81118000	15	DREG=0x00010223	0
0xC0000000	31	0x0001	1
0x80000000	≥32	0x0000	1
0x0000	≥32	0x0000	0
0x00010000	0	DREG=0x00010000	0
0x00010000	0	REG=0x0000	1

9.9. Description of internal function blocks

9.9.1. Timers T1...T8

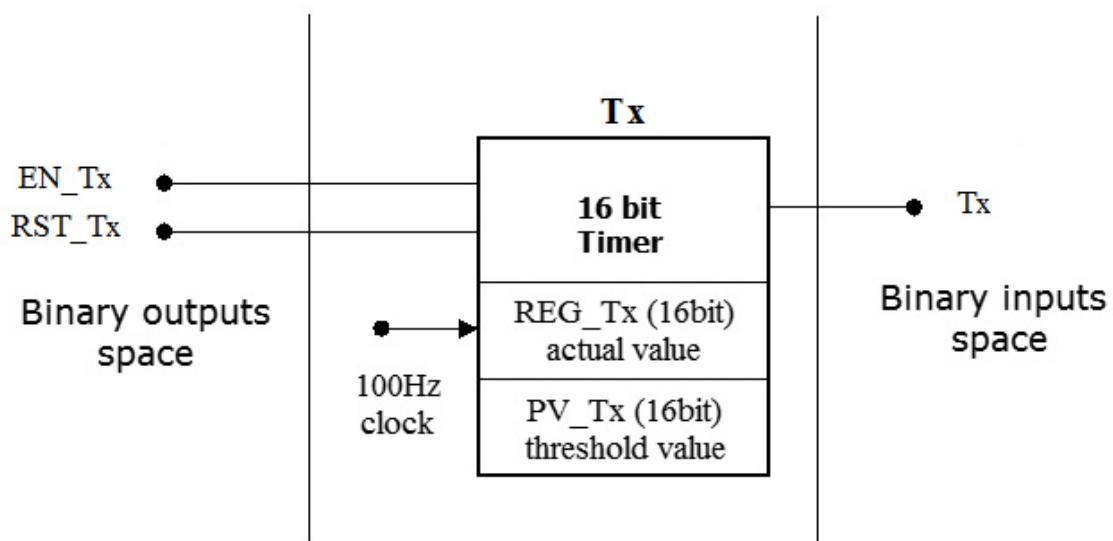

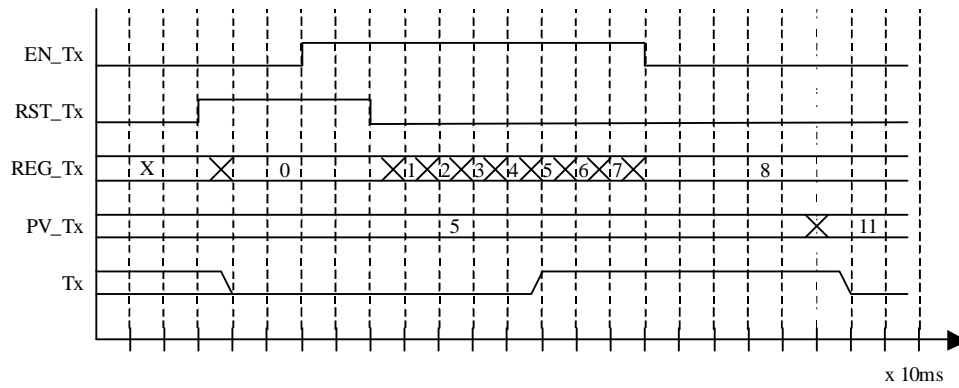

CAUTION!
All variables in Modbus address space are updated after every cycle of internal program execution - that is every 100ms.

9.9.2. Counters C1...C8

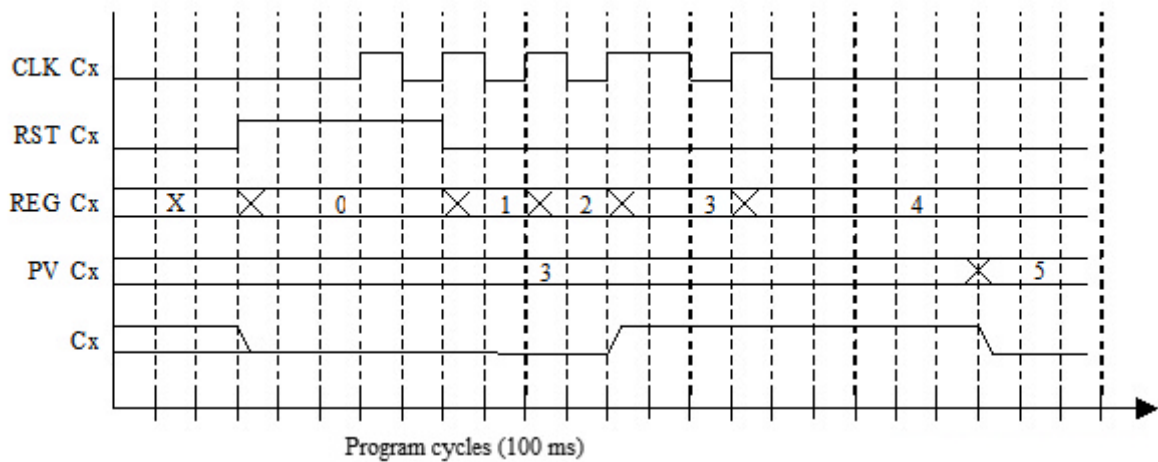
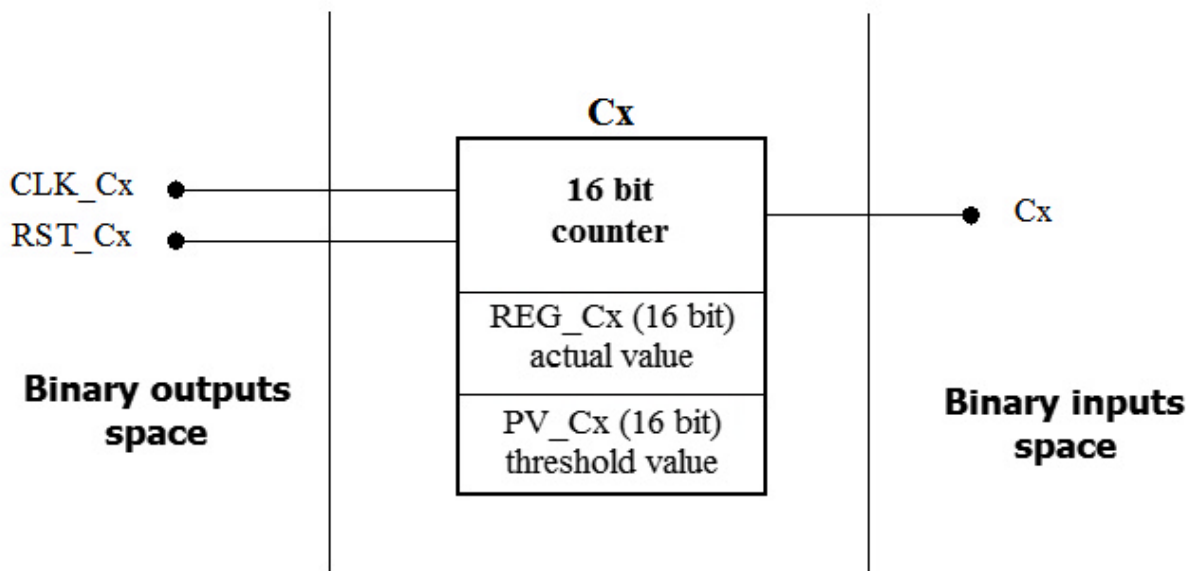

9.10. Signal levels or edges

All logical input values may be additionally affected by a level or edge condition.



The default value is a positive signal level. However, the user can change each of the input signals (Condition, Parameter X or Parameter Y) so that the program reacts to inverted value, rising edge, falling edge or change of state.

9.11. Filling and modifying program table

The program table has to be filled out with subsequent lines starting with the left column and moving towards the right column. Double-clicking on any given field in the table unfolds a list of variables or functions available to the given column.

In the "Condition" column, double-clicking unfolds a list of logical variables whose state can be checked. The name of the variable can also be entered directly by keyboard or by clicking on the 0/1 values on the numerical keypad. After selecting the name of the variable, it is also possible to define the level or edge condition the execution of the function.

Double-clicking with left mouse button causes a list of available functions to drop down. However, the function can also be selected from standard functions grouped around the numerical keypad, from the list placed above the numerical keypad or by entering the name of the function manually. In case of manual entering, a warning message will appear if the name entered manually is not identical to one of the available functions.

For the columns "Take X" or "Take Y", double-clicking with the left mouse button unfolds a box with a list of variables which may be used as arguments of the function selected earlier. These will be either arithmetic or logical variables. The same discrimination will be visible on the numerical keypad in the right side of the window. In case of logical variables, only the "0" and "1" buttons will be active. Of course, the names of variables or values can be entered from the computer keyboard. If the function can only accept one argument, it will be impossible to select and enter a second one.

The "Store result" column is filled out in a similar way. A list of modifiable variables drops down after double-clicking on the column with left mouse button. Logical and analog inputs will not be displayed. The type of variables is correlated with the previously selected function.

The optional selection in the "If error" column is limited to logical variables whose modification is possible.

Manipulation of program rows is possible after activating context menu by clicking with right mouse button.

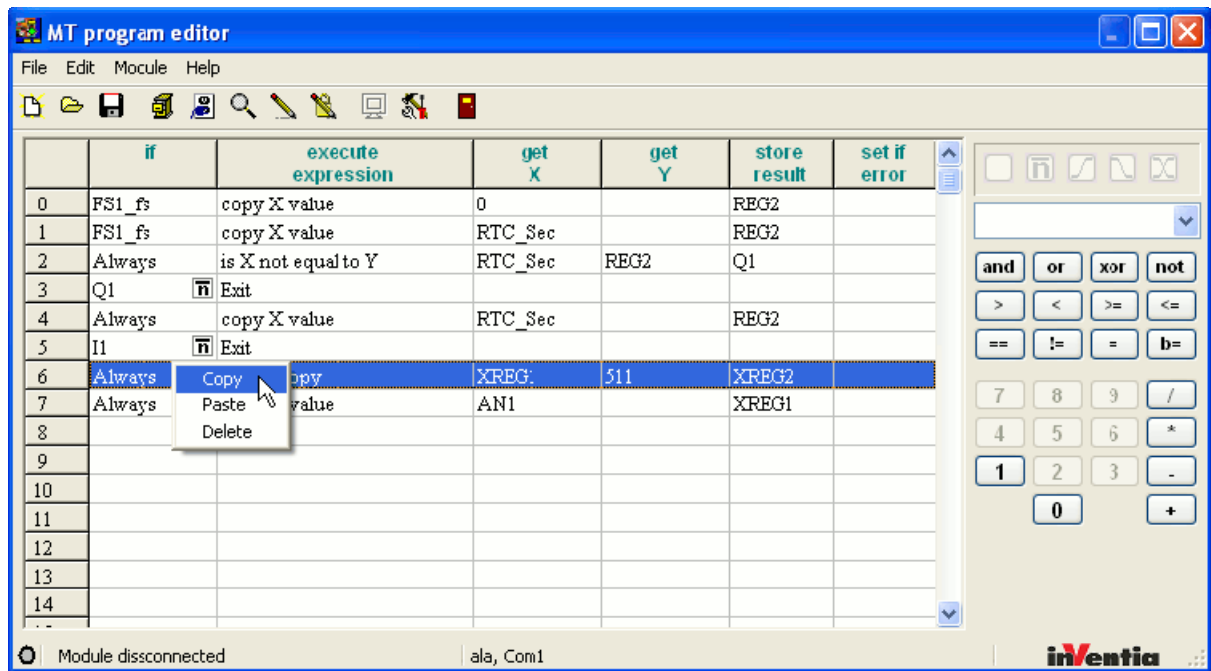

Functions of Context Menu apply for the selected table row. Copied rows are pasted above the highlighted row.

9.12. Downloading the program

After completed editing of program, data can be sent to the module.

The method of transmission depends on selected means of communication. When programming locally, it is necessary to establish RS232 cable connection.

For remote programming, it is necessary that the computer on which MTProg is running has a network connection to the APN where the module resides.

Next step is selecting "Connect" and "Write Program" or "Write and block reading". The command description can be found in section Menu Module.

9.13. Verifying the program

Despite the high reliability of both local and remote programming, it is recommended to verify the program written into the module. Especially in cases where the module does not seem to be acting according to the controlling algorithm.

The device status LED which displays possible problems resulting from errors in processing of downloaded internal programs has to be verified.

9.14. Examples of programs

This chapter aims at acquainting the user with common methods of defining algorithms. Programs included in this chapter are built on simple premises and do not take the fact that they are all made for purely educational purposes into consideration. The authors renounce any liability for faults resulting from using programs without prior analysis of circumstances.

9.14.1. The timer

This program illustrates the use of the typical timer (1 of 8 available in MTProg), activated by I1 going high (third program line). The pre-set value PV_T1 that the timer counts up to is 5s (clock frequency is 100Hz) - the line is executed only by first program

cycle. When preset value is reached, T1 flag is raised and output Q1 is set to high. The timer can be stopped before 5 seconds lapse by setting I1 low.

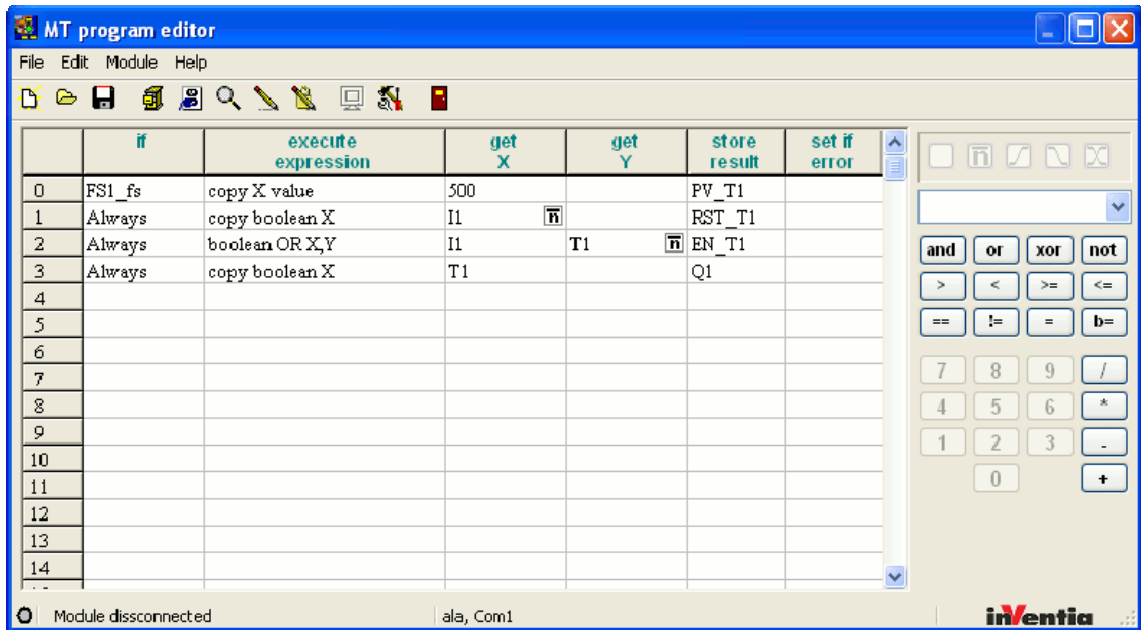

9.14.2. The counter

MTProg has 8 counters of this type. The example illustrates a counter counting 10 activations of I1. Upon reaching the count of PV_C1 the flag C1 rises. Line 2 copies the state of C1 to output Q1. Change of Q1 may be used in the rule defining the data or sms transmission or in further programming. The counter is reset (line 3) upon reaching the pre-set value of 10.

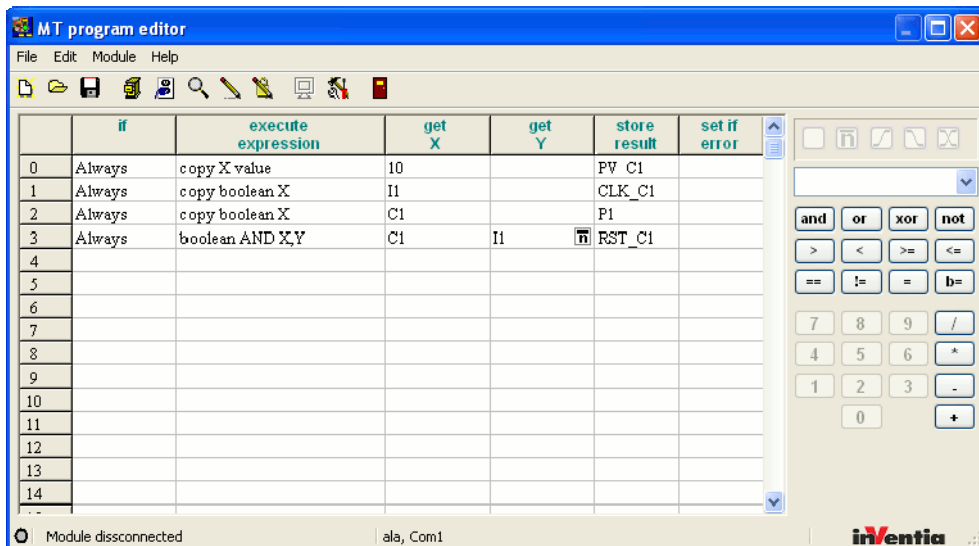

9.14.3. Pulse generator

Simple example of pulsing output Q1. The interval of switching on/off is 1 second.

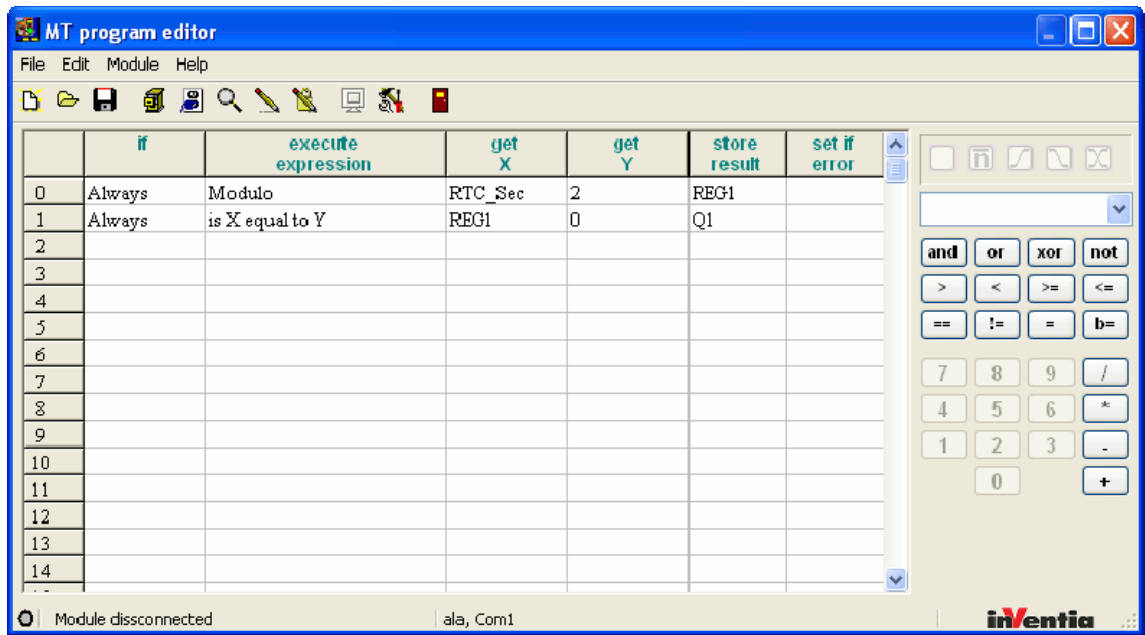

9.14.4. 2 pumps alternating action

Next example illustrates alternating work of 2 pumps activated by respective Q1 and Q2 output. When water level makes sensor on input I3 close (start level), the program turns resting output Qx on. If the water level does not decrease and the sensor on I4 gets activated, the resting pump is switched on and stays on until the level drops to under stop level (I2). There is an auxiliary security measure in the program in case of the I2 sensor hanging, where the program turns both pumps off if Dry run (I1) level is crossed. Note that in order to start the pump, I1 and I2 have to be ON when I3 gets activated.

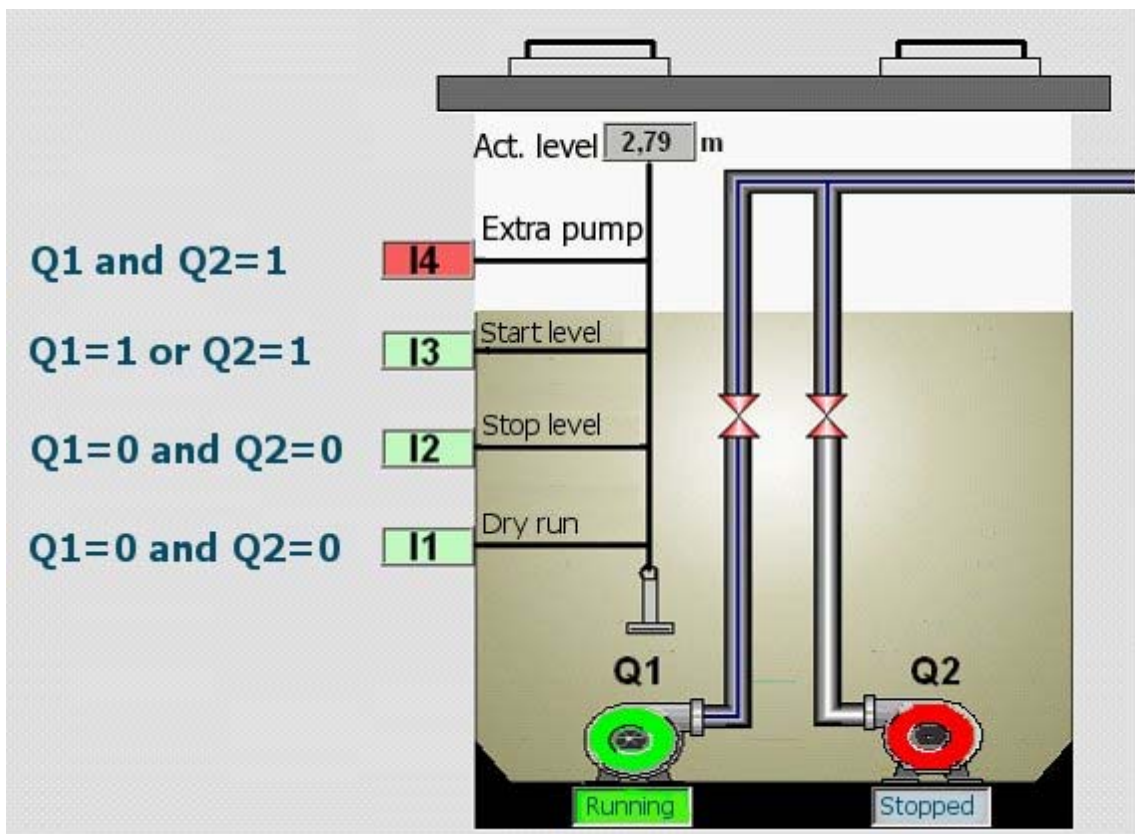

* - value 1 shifts between Q1 and Q2 depending on their state in last working cycle (if Q1=1 and Q2=0 then in next cycle it will shift to Q1=0 and Q2=1)

The first program line resets REG1 to 0 (executed only on first scanning of program- later on omitted since the condition is not met). Operations on REG1 and M0 flag prepare tasks for the next sequence of pumping using Q1 and Q2. Altering functionality is based on checking the value of the first bit in REG1. The bit changes its value for each change of M0 marker).

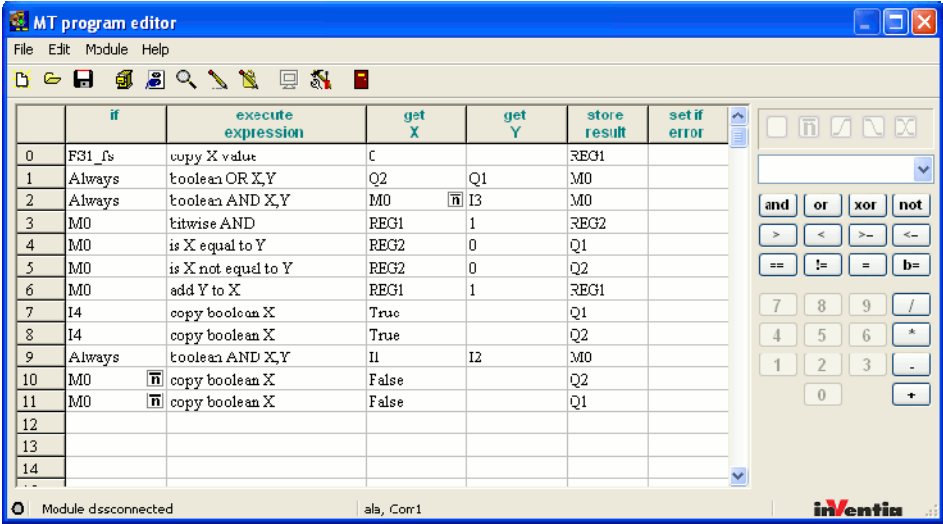

9.14.5. 3 pumps toggle action

In this example, the levels of starting and stopping of 3 binary outputs are designed exactly as the previous example for two pumps (I1,I2,I3,I4). The pumps alternate between Q1 Q2 and Q3. The difference is that when I4 is activated, the auxiliary pump goes into action. For instance when Q3 is running Q1 serves as auxiliary pump and so on..

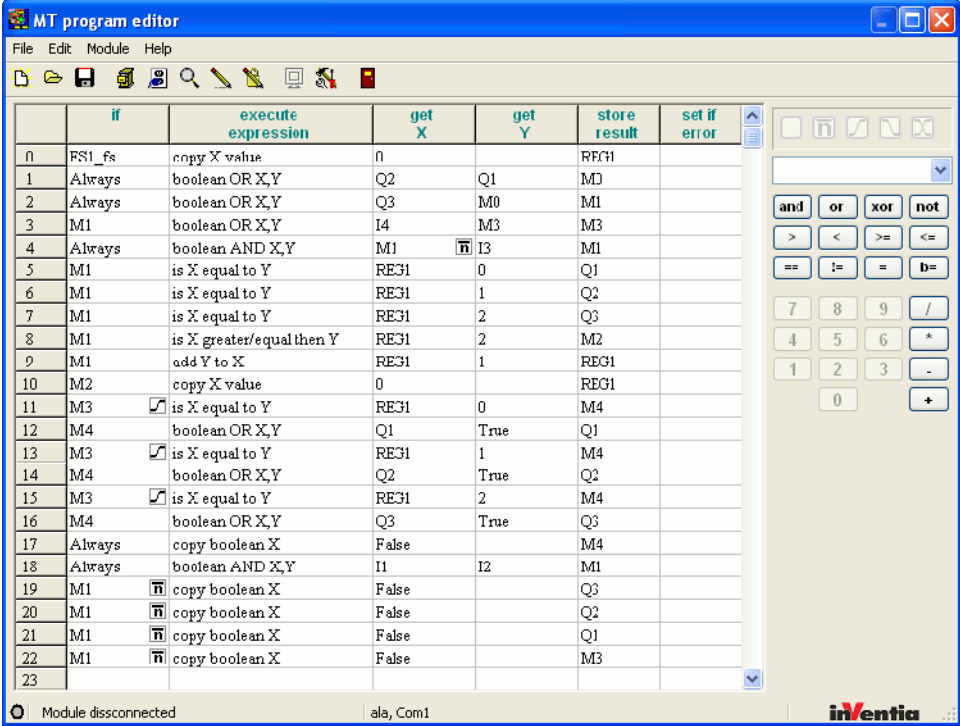

9.14.6. Checking bit's value in the registry

In case of MT-101-to-MT-101 communication (the cascade system), it is necessary to test values of receiving module's registers holding the status received last via GPRS from sending module. MTProg recognizes it as: RMT_IN (input space), RMT_ID_OUT (sender's ID + output space), RMT_AN1 and RMT_AN2 (input AN1 respectively AN2).

Scheme:



Create the rule sending status triggered by any change of I1 addressed to remote module

Download the program that checks RMT_IN and the value of bit 9 (corresponding to senders I1 input value) and sets Q1 accordingly.

As the result, the value of binary input I1 at sending module will be mirrored by receiving module's binary output Q1.

Line 0 copies the bit 9 of RMT_IN into REG1. Line 1 compares REG1 to 256 (value of bit 9) and sets Q1 accordingly to the actual value.

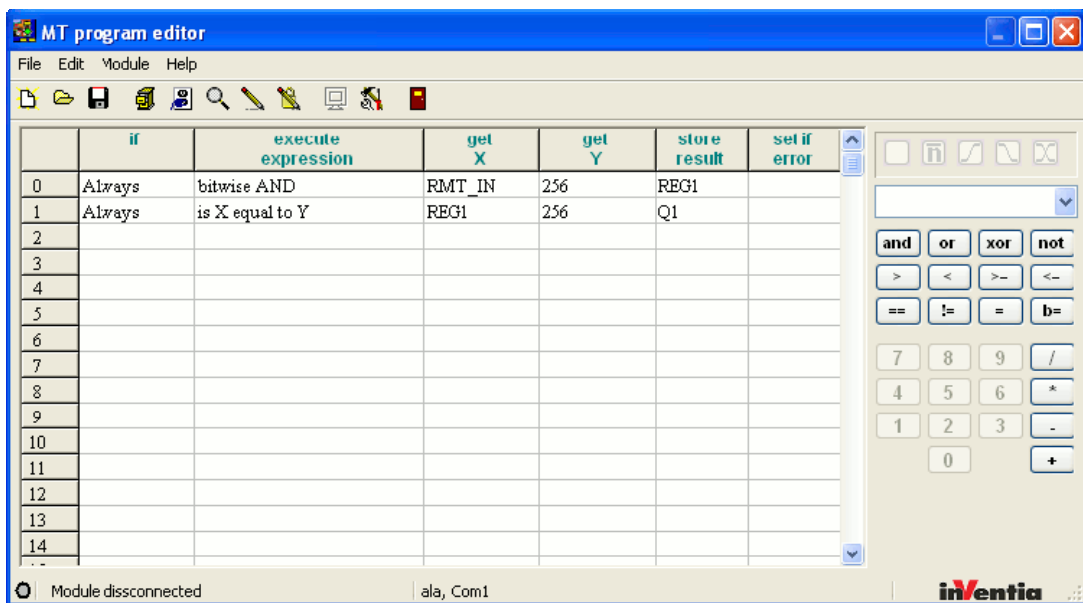

The same effect can be obtained in more elegant way employing function "Bit test":

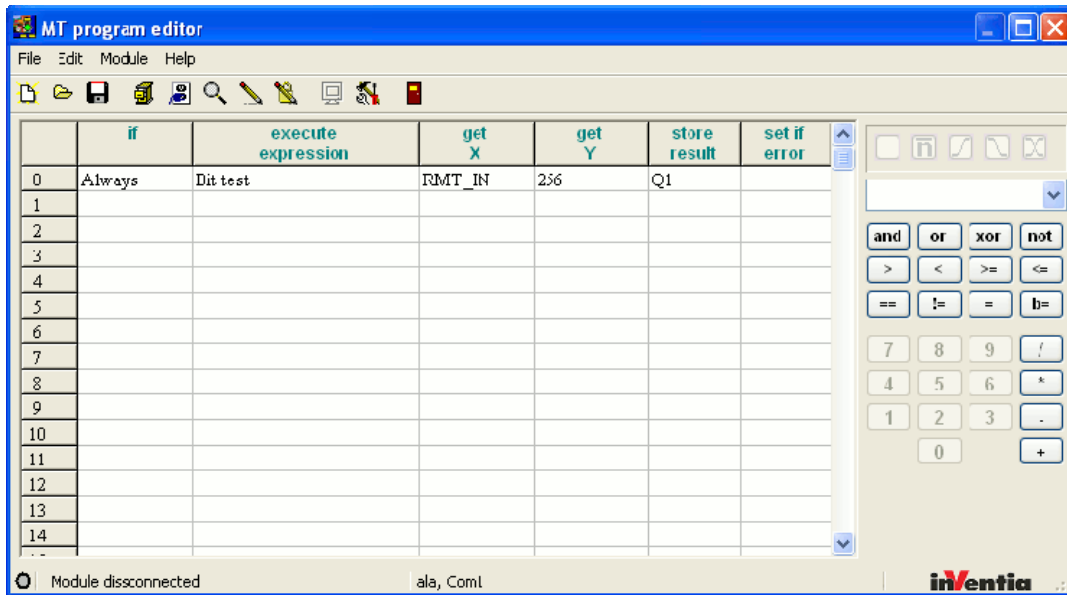

9.14.7. Alarm with confirmation

The program generates cyclic transmission of SMS messages until I5, declared as alarm confirmation, is activated or the alarm condition ceases (I1=0)

When binary input I1 is activated, output Q1 is set high. (In MTManager - the rule triggered by Q1 sending SMS is defined). Simultaneous to I1 going high, the timer 1 is activated and counts to PV_T1 amounting 600 (6 seconds) starts. Upon reaching PV_T1, the flag T1 is set and subsequently Q1 is set. As a result of the rule, an SMS message is dispatched. Until I5 is activated or I1 deactivated, SMS messages will be regularly dispatched.

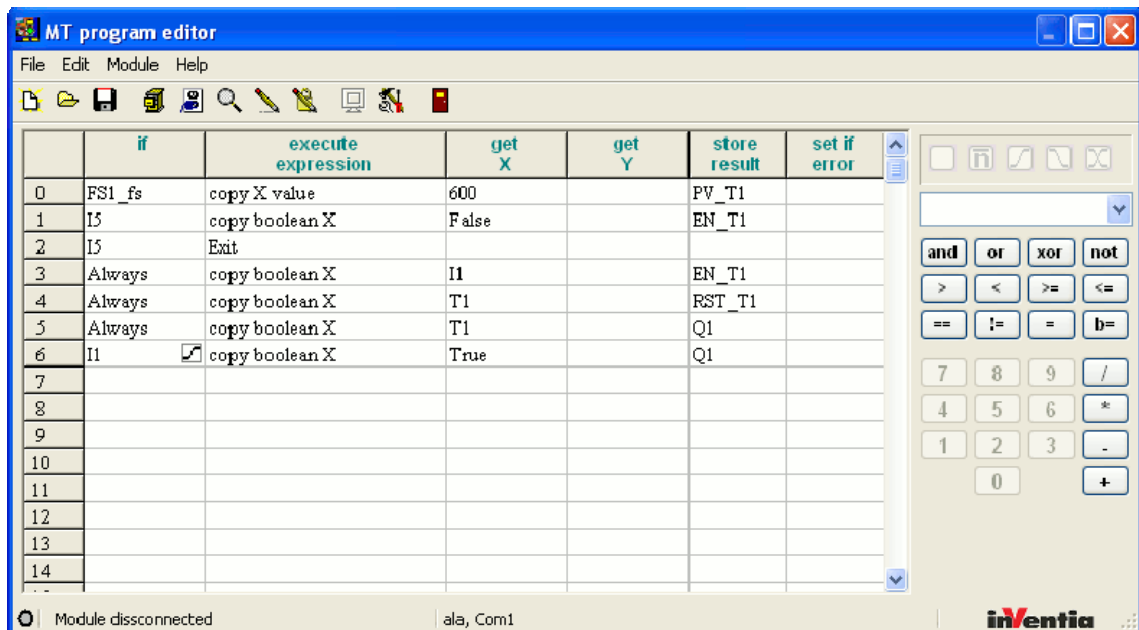

9.14.8. Motion detector

The motion detector is connected to I1 and light source to Q1. When I1 is activated, the module turns the light on for 10 seconds. Repeated activation of I1 resets the time count back to 10 seconds.

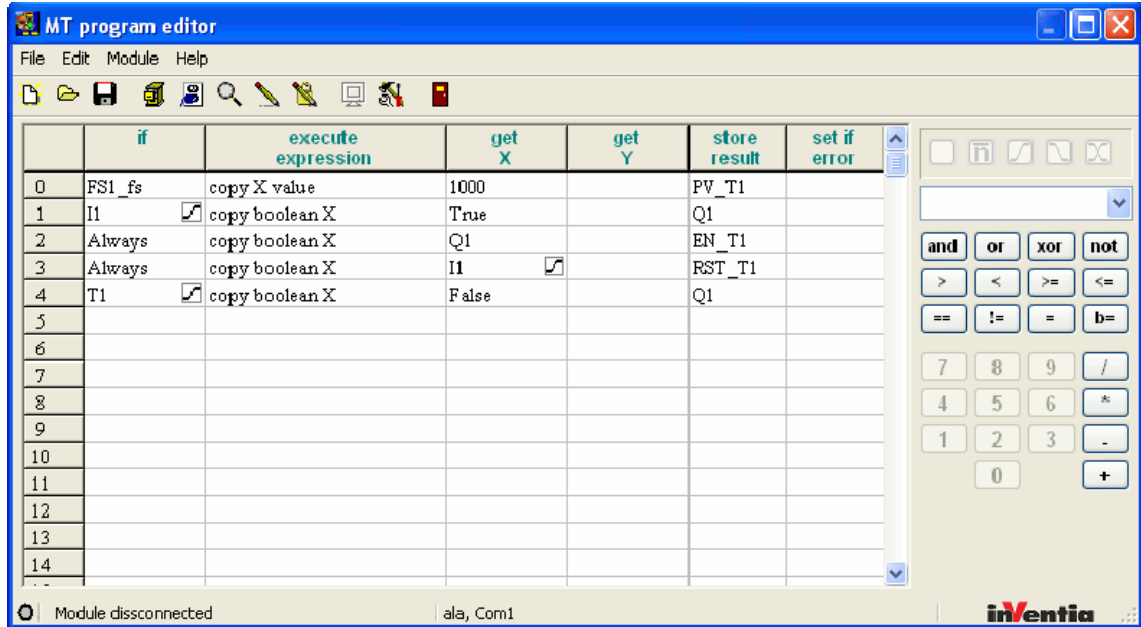

9.14.9. Logger program

An example of creating 512 elements logger for AN1 with 1 sec interval activated when I1 = 1.

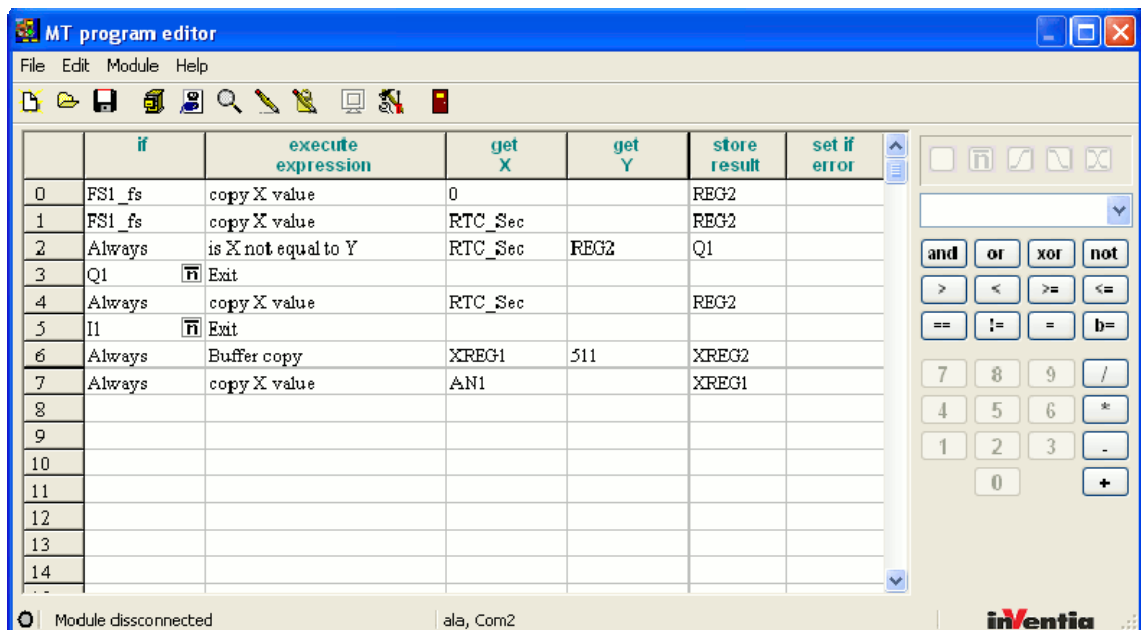

10. Problem solving

10.1. LED signaling

LED indicators placed on front panel of the **MT-101** module are very convenient during start-up procedure. In order to understand their message please get acquainted with error codes.

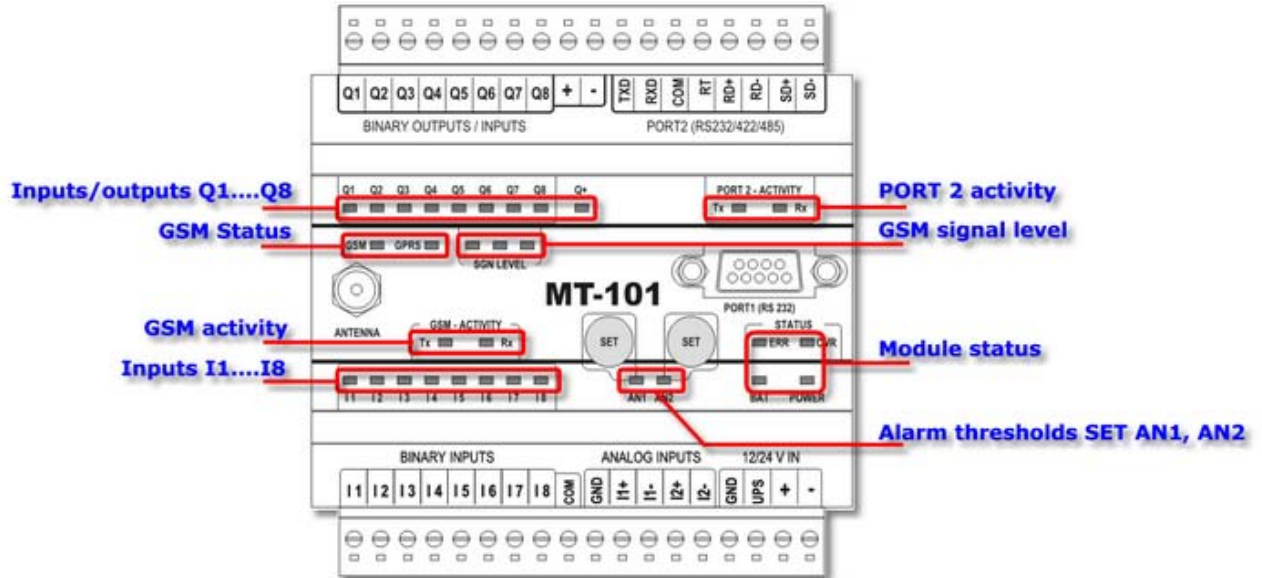

Click on the LED area you want to get information about.

10.1.1. Inputs/Outputs Q1....Q8

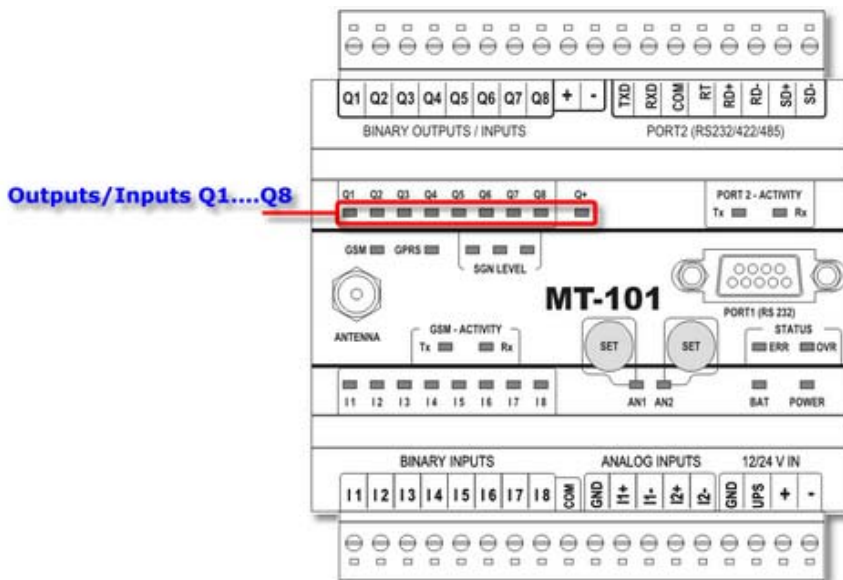

LED indicators for *outputs/inputs Q1....Q8* group signal both High state of forced output signal and High state of input signal in cases where output Q1...Q8 operates as binary input. Visual evaluation of current input/output state makes working with the module much easier.

Flashing 2 Hz. output LED signifies that there is a discrepancy between intended output state and its actual state. This usually occurs when the load is missing or the circuit is shorted.

10.1.2. Inputs I1...I8

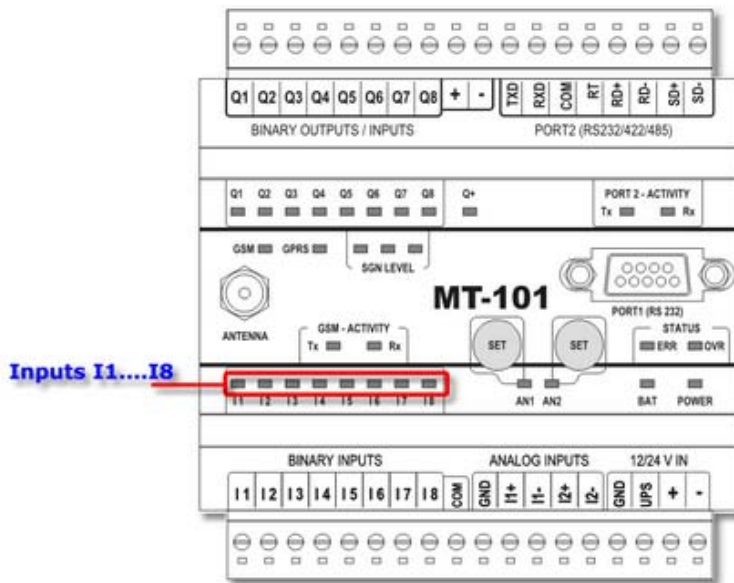

LED indicators of *Inputs I1...I8* signal high state of binary signal connected to I1...I8 inputs. It takes place regardless of whether the module operates in positive or negative logic. Visual evaluation of current input state makes working with the module much easier.

10.1.3. GSM status

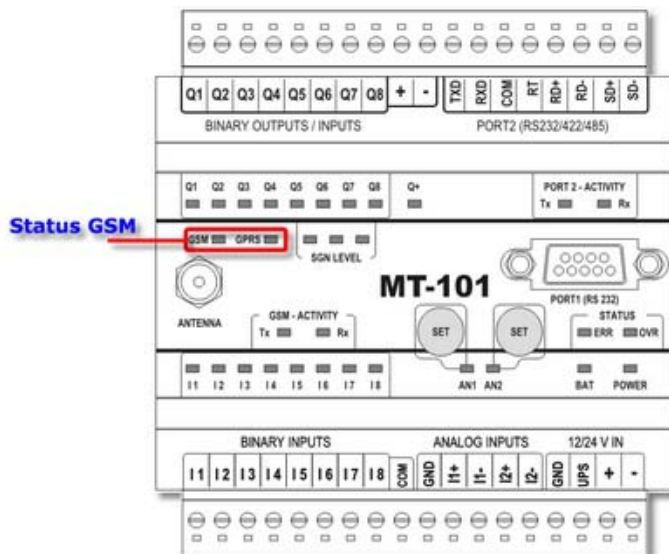

GSM Status LEDs indicate:

GSM LED- reflects current login to GSM network state.

- lit - the module not logged in
- flashing with app. 2 Hz frequency - the module is logged in

GPRS LED - when lit, signifies proper login to APN.

LED indicators for *GSM Status* group reflect module's readiness to perform its duties. Modules not logged in GSM/GPRS network are not able to transmit data and performs cyclic resets and retries to log in.

10.1.4. GSM activity

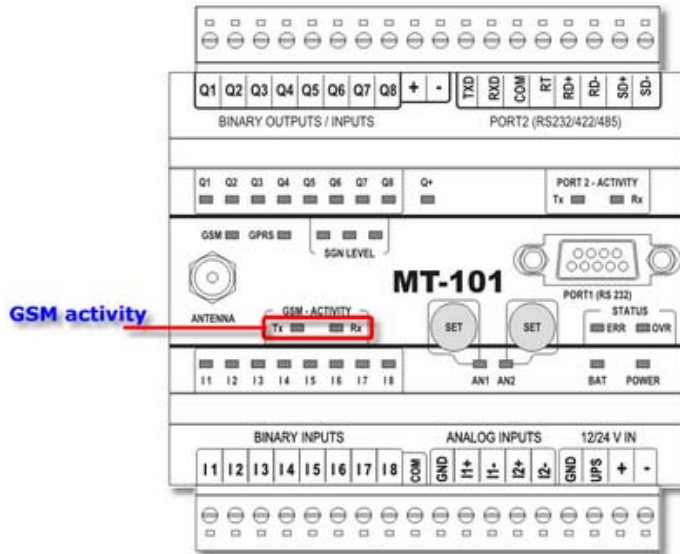

LED indicators **Tx** and **Rx** of *GSM activity* signal, respectively, transmitting and receiving of data via GPRS. Since SMS sending is a form of data transmission, both data frame transmission and SMS transmission cause short flashes of **Tx** LED. Short flashes of **Rx** LED indicate either SMS or data frame reception. This is an easy way of detecting transmission activities.

10.1.5. GSM signal level

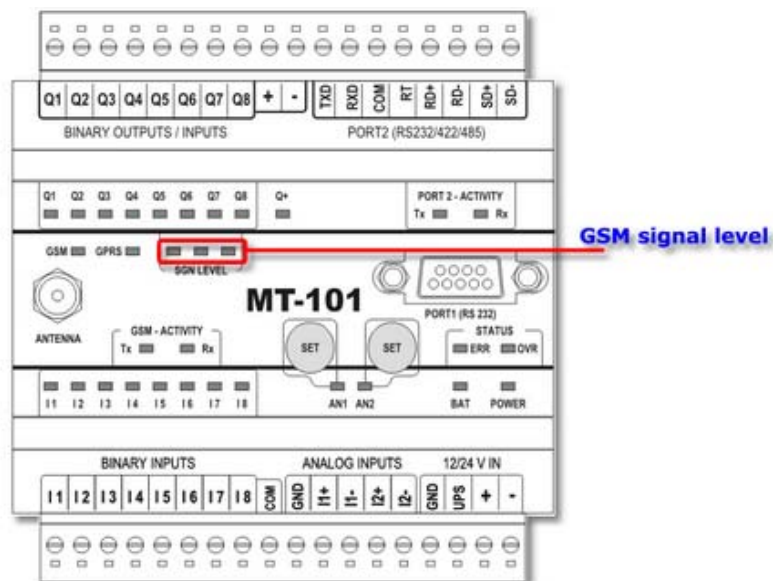

LED indicators of *GSM Signal level* display information received from GSM network on signal level in the place where the antenna is mounted. It is presumed that for reliable operation at least one LED is lit. Lower level signal does not guarantee reliable operation and means that antenna placement should be changed or the antenna should be replaced with one securing higher signal level.

Reading of signal level happens in the moment of login to network and every 12 minutes, if the module operates in SMS mode. Selection of GPRS mode only means that signal level is investigated only during login procedure, typically at power up. That does not pose any danger since no disturbances in module's operation mean that the signal strength is sufficient.

10.1.6. PORT 2 activity

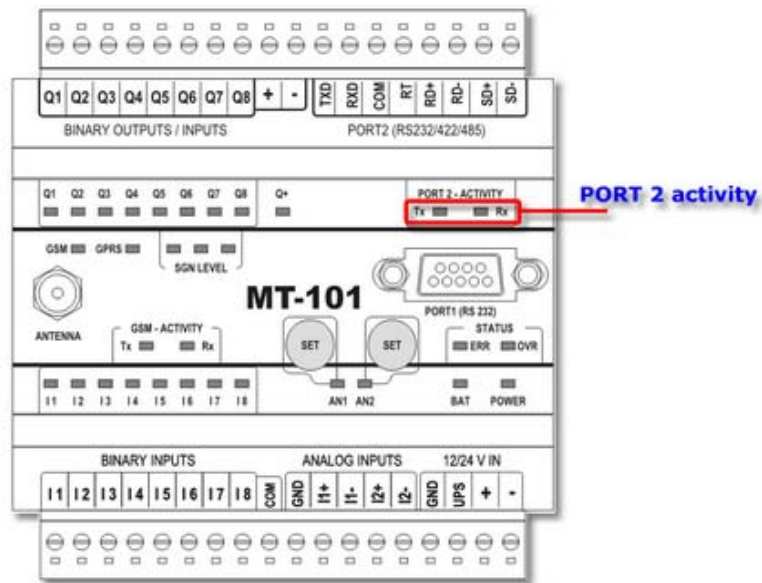

LED indicators **Tx** and **Rx** of *PORT 2 Activity* display, respectively, sending and receiving data via PORT2.

The activity may be observed when:

- The Module operates in *Modbus RTU Master* mode and communicates with attached Master device, passing GPRS received data.
- The Module operates in *Modbus RTU Slave* mode and has sent received query to PORT 2 for Modbus ID different than its own
- The Module operates in *Modbus RTU Mirror* and sends queries for attached SLAVES to PORT 2.
- The Module operates in *Transparent* or *Transparent PLUS* mode and reroutes data received via GPRS to PORT 2
- The Module operates in *GazModem* or *M-Bus LEC* mode and communicates with attached devices.
- The Module operates in *NMEA0183* mode and receives data from attached device. Activity is observed only on **Rx** LED.
- The Module operates in *Modem* mode and communicates with superior device.
- The Module operates in *FlexSerial* mode running built in port service for communication with device working on non standard transmission protocol.

In *MT Slave* PORT 2 mode is inactive so **Tx** and **Rx** LED's show no activity.

10.1.7. Module's status

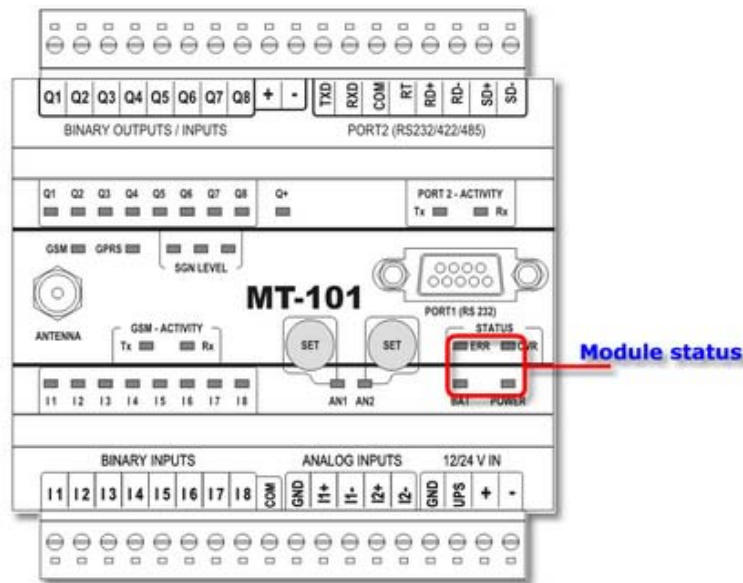

Module status group encompasses four LED indicators displaying the state of the circuit controlling the module's operation and with execution of user-defined program.

Significance of LED indicators:

- **Err** LED - when lit, the **Err** LED indicates an error forcing automatic reboot. The reason may be lack of GPRS communication disabling transmission of awaiting data. Triple flash of Err LED indicates that current firmware does not support the function used in the program. In this situation, one solution is updating the firmware.
- **Ovr** LED - when lit, the **Ovr** LED indicates that execution of the program cycle took over 100ms and the next cycle was delayed as the result and may render improper execution of the program.
The LED is lit in following cases:
 - the program loaded is stopped,
 - a new configuration or firmware is loaded and internal program was automatically stopped in order avoid interference. In that case make sure not to disrupt the power supply until the module restarts automatically. It may take couple of minutes.
- **Bat** LED - is lit when the potential on UPS input falls below 13,8V. Since this input is used to signal main supply failure, the system flag FS1_ups is raised simultaneously. The FS1_ups flag may be used in rules processing.
- **Power** LED - is lit all the time the module is supplied with power.

Indicators of *Module status* group are the main sources of visual information about correct operation of the module.

10.1.8. SET1, SET2 alarm thresholds

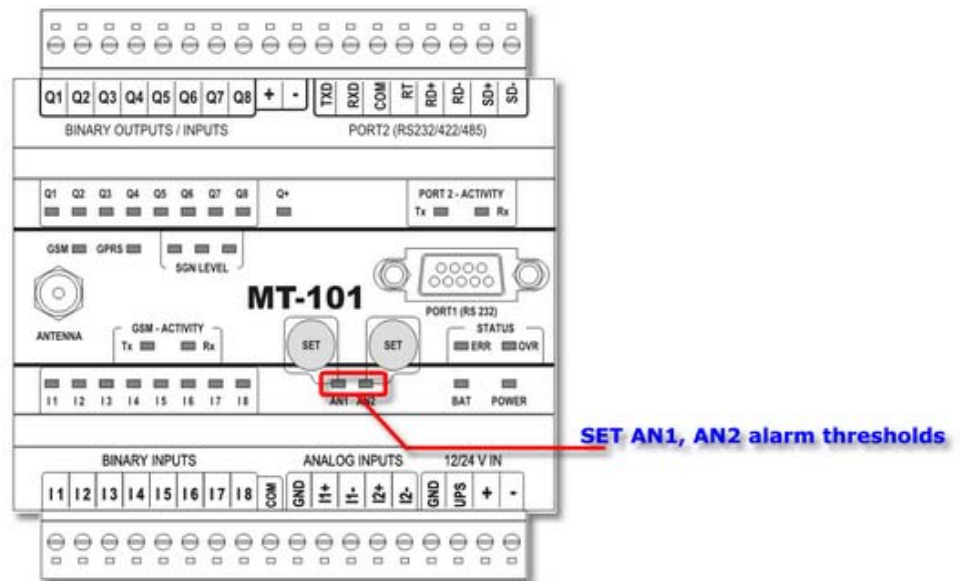

The *Alarm thresholds SET1, SET2* group encompasses two LED indicators placed in the neighborhood of two SET buttons placed on the front panel. The buttons are connected to analogue inputs A1 respective A2 and indicators are marked as **A1** and **A2**. Threshold indicators SET1 and SET2 are lit when value of analogue signal at corresponding input crosses the manually set alarm threshold.

10.2. Unblocking of SIM card

Three failed attempts of entering PIN code locks the SIM card and requires entering the PUK code. In order to prevent this, the module controls the number of failed attempts written into SIM card by allowing only two attempts making a third attempt impossible even if the third attempt was correct.

A double unsuccessful attempt is perceived as a fault requiring user intervention. An attempt to unlock the module may be performed only when the right PIN code is known.

Necessary procedure:

- turn the power supply off
- remove SIM card from the module
- insert SIM to ordinary mobile phone accepting cards from the operator that issued actual SIM
- start the phone and enter proper PIN code
- if not accomplished before...
 - start the module
 - insert appropriate PIN into configuration
 - power the module off
- remove the SIM from the phone and place it in the module
- start the module

The described procedure reset SIM card's fault counter and allow using the card in **MT-101** module.

In older versions of GSM modems without implemented protection procedures the SIM card may get blocked after 3 failed attempts and the only method of unblocking it is to supply the right PUK code. Unfortunately this cannot be performed in the MT-101 module.

The PUK code may be inserted only after taking the SIM card out of MT-101 module and placing it in a standard GSM mobile phone. The phone will demand entering of PUK code at power-up. Entering correct PUK-code unblocks the card and resets PIN fault counter making the card operational.

10.3. Error signaling

Despite the efforts of module designers and users errors in function do occur. It is often imperative to diagnose and remove the cause of error. Error signaling is a tool for solving problems.

LED indicators on module's front panel interpret errors:

- **ERR**
- **GPRS**
- **L1, L2, L3** of **SGN LEVEL** group

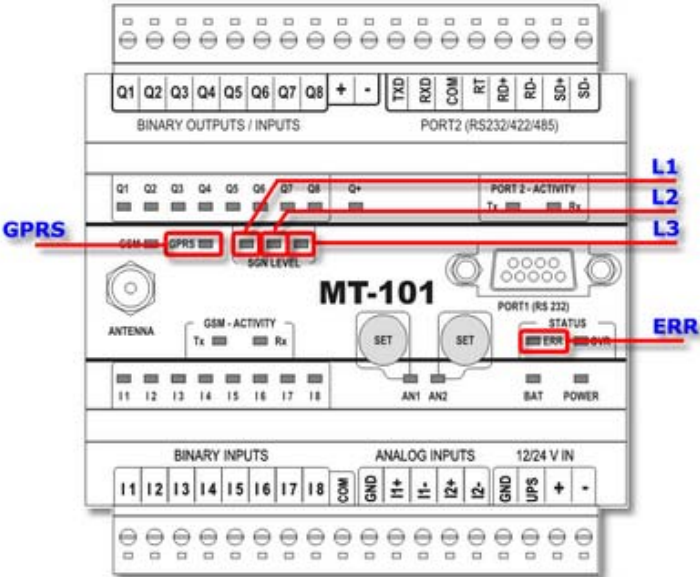

Depending on type, errors are classified as standard or critical. Standard errors are a result of faulty configuration or reasons independent of the module. Critical errors are usually connected to physical damage or faults in internal program.

10.3.1. Standard errors

A sign of **Standard error** occurrence is a lit **ERR** LED. Error code numbers are displayed on signal level and **GPRS** LEDs.

<i>ERR</i>	<i>State</i>
○	lit

<i>GPRS</i>	<i>L1</i>	<i>L2</i>	<i>L3</i>	<i>Error no</i>	<i>Description</i>
●	○	●	●	1	Modem error
●	●	○	●	2	GSM network error - check antenna connection and SIM card activation in GSM network.
●	○	○	●	3	GPRS network error - check SIM card activation in GPRS network
●	●	●	○	4	Wrong user name or password for GPRS network
●	○	●	○	5	Log in to GPRS error
●	●	○	○	6	Connection interrupted
●	○	○	○	7	Other error
○	●	●	●	8	
○	○	●	●	9	SIM card error (locked or missing)
○	●	○	●	10	
○	○	○	●	11	
○	●	●	○	12	
○	○	●	○	13	Number of log into GPRS trials exceeded
○	●	○	○	14	Module blocked
○	○	○	○	15	Wrong PIN for SIM card

○	LED flashing (0,5Hz)
●	LED off

When GPRS LED is off the module is automatically trying to reinitiate transmission. When GPRS LED is flashing user intervention is required. Remove the reason for error and recycle the power.

10.3.2. Critical errors

A sign of **Critical error** is the flashing of **ERR LED**. Error code numbers are displayed on signal level and **GPRS** LEDs.

<i>ERR</i>	<i>State</i>
○●	flashes (0,5Hz)

<i>GPRS</i>	<i>L1</i>	<i>L2</i>	<i>L3</i>	<i>Error nr</i>	<i>Description</i>
●	○	●	●	1	BOOT module error
●	●	○	●	2	Main program error
●	○	○	●	3	Update error
●	●	●	○	4	RAM_N error in CPU
●	○	●	○	5	External RAM error
●	●	○	○	6	
●	○	○	○	7	Stack overflow
○	●	●	●	8	
○	○	●	●	9	
○	●	○	●	10	
○	○	○	●	11	
○	●	●	○	12	
○	○	●	○	13	
○	●	○	○	14	
○	○	○	○	15	Undefined error
All LED indicators are flashing					RAM_T memory error in CPU

○	flashing LED (0,5Hz)
●	LED off

Occurrence of any errors described above indicates either a fault in program or a module defect. If a critical error occurs, please note the error code and contact the manufacturer.

11. Technical data

11.1. General

Dimensions (height x width x length)	105x86x60 mm
Weight	300 g
Mounting method	DIN rail 35mm
Operating temperature	-20 ⁰ ... +55 ⁰ C
Protection class	IP40
Max. potential on any connector referenced to GND	60Vrms max.
Humidity	5 ... 95% non condensing

11.2. GSM/GPRS Modem

Data for WISMO Quick 2406B

Modem type	WISMO Quick 2406B
GSM	Dual Band GSM/GPRS module EGSM900/1800
Frequency range (EGSM 900 MHz)	Transmitter: from 880 MHz to 915 MHz Receiver: from 925 MHz to 960 MHz
Peak transmitting power (EGSM 900 MHz)	33 dBm (2W) – class 4 station
Frequency range (EGSM 1800 MHz)	Transmitter: from 1710 MHz to 1785 MHz Receiver: from 1805 MHz to 1880 MHz
Peak transmitting power (EGSM 1800 MHz)	30 dBm (1W) – class 1 station
Modulation	0,3 GMSK
Channel spacing	200 kHz
Antenna	50Ω

Data for WISMO Quick Q 24 PLUS

Modem type	WISMO Quick Q24 Plus
GSM	Multiband GSM module (900/1800 or 850/1900)MHz
GPRS	Class 10
Frequency range (EGSM 900 MHz)	Transmitter: from 880 MHz to 915 MHz Receiver: from 925 MHz to 960 MHz
Frequency range (GSM 850 MHz)	Transmitter: from 824 MHz to 849 MHz Receiver: from 869 MHz to 894 MHz
Peak transmitting power (EGSM 900 MHz & GSM 850 MHz)	33 dBm (2W) – class 4 station
Frequency range (EGSM 1800 MHz)	Transmitter: from 1710 MHz to 1785 MHz Receiver: from 1805 MHz to 1880 MHz
Frequency range (PCS 1900 MHz)	Transmitter: from 1850 MHz to 1910 MHz Receiver: from 1930 MHz to 1990 MHz
Peak transmitting power (EGSM 1800 MHz & PCS 1900 MHz)	30 dBm (1W) – class 1 station
Modulation	0,3 GMSK
Channel spacing	200 kHz
Antenna	50Ω

11.3. Power supply

Direct Current DC (12V, 24V)	10,8 ... 36V
Alternating current AC (24V)	18...26,4Vrms
Input current (A) (for 12V DC)	Idle 0,10 Active 0,60 Max 1,90
Input current (A) (for 24V DC)	Idle 0,06 Active 0,25 Max 1,00

CAUTION!
Due to high momentary current consumption the power supply must be capable of delivering $\geq 2A$ of current.

Inappropriate power supply may result in faulty operation or cause damage to MT-101 module!

11.4. Binary inputs I1...I8

Input voltage range	-36 ... 36V
Input resistance	5,4 k Ω
Input voltage ON (1)	> 9V or < -9V
Input voltage OFF (0)	-3V ... 3V
Frequency range in analogue mode	0....2kHz
Min pulse length "1"	5ms

11.5. Binary outputs Q1...Q8

Operating as binary output

Recommended mean current for single output	50mA
Single output current	350mA max.
Mean current for all outputs	400mA max.
Voltage drop for 350mA	< 3,5V max.
OFF state current	< 0,2mA max.

Operating as binary input/counter

Input voltage range	0 ... 36V
Input resistance	5,4 k Ω
Input voltage ON (1)	> 9V
Input voltage OFF (0)	< 3V max
Frequency range in analogue mode	0....2kHz
Min pulse length "1"	5ms

11.6. Analog inputs A1, A2

Measuring range	4 ... 20 mA
Max input current	50 mA max.
Dynamic input impedance	25 Ω typ.
Voltage drop for 20mA	< 5V max.
A/D converter	10 bytes
Accuracy	$\pm 1,5\%$ max.
Non linearity	$\pm 1\%$ max.

11.7. Drawings and dimensions

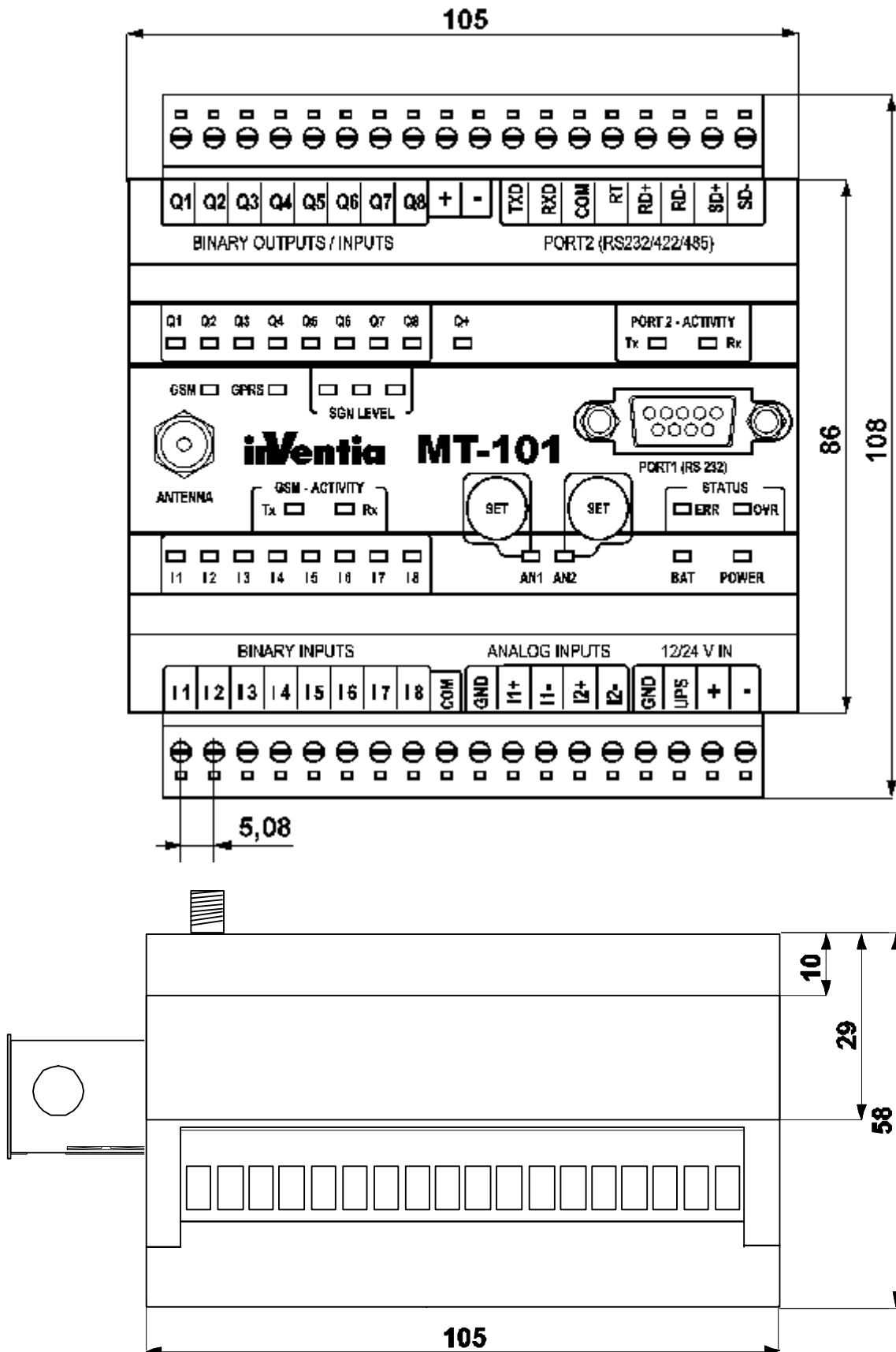

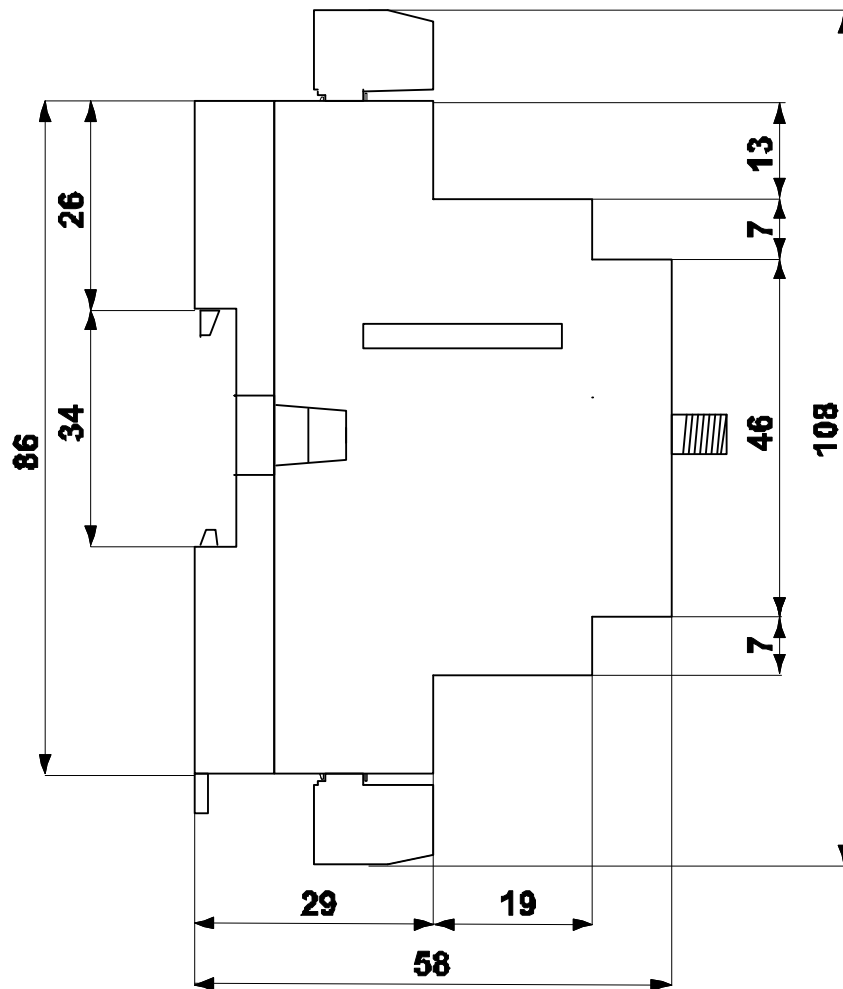

NOTE!
All dimensions are in millimeters!

12. Safety information

12.1. Working environment

When deploying telemetry modules one has to observe and comply to local legislation and regulations. Using the telemetry module in places where it can cause radio noise or other disturbances is strictly prohibited.

12.2. Electronic equipment

Though most of modern electrical equipment is well RF (Radio Frequency) shielded there is no certainty that radio waves emitted by the telemetry module's antenna may have negative influence on its function.

12.2.1. Heart pacemakers

It is recommended that the distance between the antenna of telemetry module and the Heart Pacemaker is greater than 20 cm. This distance is recommended by manufacturers of Pacemakers and in full harmony with results of studies conducted independently by Wireless Technology Research.

12.2.2. Hearing aids

In rare cases the signal emitted by the telemetry module's antenna may disturb hearing aids functions. Should that occur, one has to study detailed operating instructions and recommendations for that particular product.

12.2.3. Other medical equipment

Any radio device including the telemetry module may disturb the work of electronic medical equipment.

When there is a need of installing telemetry module in vicinity of medical equipment one has to contact the manufacturer of this equipment in order to make sure that the equipment is adequately protected against interference of radio frequency waves (RF).

12.2.4. RF Marked equipment

The restriction against installing telemetry modules in areas marked as radio frequency (RF) prohibition zones must be unconditionally observed.

12.3. Explosive environment

Installation of telemetry modules in the environment where explosion hazard is present is not permitted. Usually, but not always, these places are marked with warning signs. Where there is no marking do not install telemetry modules at liquid or gas fuels stores, inflammable materials stores, nor places contaminated with metal or wheat dust.

13. Appendices

13.1. Data transmission in GSM systems

At the moment, a subscriber to GSM services has 3 technologies of sending data at his disposal besides voice communication. These are: SMS, CSD and GPRS. Since they offer different functionalities a short description is necessary.

13.1.1. SMS

„Short Message Service“ - the technology of sending text messages. The length of the message is 160 characters. Permitted characters are letters and numbers. Despite of its popularity it is not an optimal service for telemetry. The cost of an SMS is constant regardless of information length (within 160 characters limit).

In telemetric applications, using the text mode would require dedicated formatting and special programming for reception. The conclusion is simple. This service was not created for telemetry applications but may be an attractive supplement.

Suppose that along with monitoring current values, it is possible to receive perfectly readable textual information containing a warning about alarm situation.

It is quite a useful supplement.

13.1.2. CSD (HSCSD)

„Circuit Switched Data“ - a technology for sending data via commuted communication channel set up on subscriber demand. Despite using a digital telephony technology the data transmission is analogical to traditional telephone modem.

The user establishes a connection with a defined subscriber number and carries out a transmission of data stream sent to the serial port connected to the GSM modem. It is a point-to-point transmission where only 2 data sources are connected. After transmission, the connection is broken and the subscriber charged for the time occupying the channel.

This type of data transmission justifiable when large amounts of data are to be transmitted but would be extremely expensive in real time monitoring since it occupies the channel all of the time.

13.1.3. GPRS

„General Packet Radio Services“ – a technology of transmitting data as addressed digital packets. Seen from user's point of view it is identical to Internet technology. The technology uses packet data protocols, particularly UDP/IP and TCP/IP.

This technology is radically different from technologies employed by standard modems using GSM/CSD commuted mode.

The main difference is the inability to transmit the stream of data directly in traditional serial protocols.

For transmission by GSM/GPRS modem it is necessary to "package" data in frames compatible with employed protocol.

All procedures necessary for login to GPRS have to be completed, so connecting GSM/GPRS modem to the data source operating in serial protocol (MODBUS, PPI, SNP, M-Bus....) incompatible with packet transmission specification is impossible - even if it has a serial interface.

After completing login sequence we have a connection equal to virtual "wired connection" available all of the time.

13.1.3.1. Advantages of GPRS technology

The absolutely greatest advantage of GPRS technology is the possibility for maintaining a permanent connection with the network while paying only for the volume of transmitted data with no charge for maintaining the connection. This makes establishing of "on line" services for minimal expenses possible. An additional advantage is potentially high transmission speed (up to $\sim 170\text{kb/s}$), facilitating high data volume transmission.

GPRS standard supports four channel encoding schemes named respectively CS1 to CS4 with throughput of

9,05 kb/s, 13,4 kb/s, 15,6 kb/s and 21,4 kb/s.

Reached this way, maximal transmission rates though rigidly defined are different depending on the number of connected channels and limited usually to max throughput of 115,2 kb/s (typically $8 \times 13,4\text{kb/s} = 107,2\text{ kb/s}$), and in particular situations even up to 171,2 kb/s ($8 \times 21,4 = 171,2$).

13.1.3.2. GPRS in telemetry applications

GSM/GPRS technology is possibly the ideal solution for telemetry and control of dispersed objects.

The undisputable advantages are:

- Use of an existing advanced structure of GSM transmission structure.
- The gigantic range of the network – works everywhere!
- Low cost of establishing and utilizing the system
- No need for specialized antenna systems
- The possibility of building networked systems
- No necessity for retransmission
- Full access protection on operator and hardware level
- Cost of transmission system maintenance rests with network operator
- Easy rescaling and reconfiguration of the system
- Great availability of various receiving terminals
- Easy setup of temporary systems
- Only transmitted data volume is charged

For proper operation of terminals - GSM/GPRS network nodes, one needs a SIM card with GPRS service enabled, permission to log in to existing APN and a static IP assignment. A static IP address is the base for addressing terminals in packet transmission GPRS networks.

Note that when using GPRS for real time monitoring, packet transmission networks add a delay dependent of the route the addressed packet has to go between the sender and recipient terminal. Usually this delay does not exceed a few seconds and is insignificant from a monitoring perspective. In turn, the possibility of creating networks independent of terrain topography and territorial size of the system is gained.

13.1.4. EDGE

EDGE (Enhanced Data rates for GSM Evolution) is a technology for data transmission employed in GSM networks.

This is an extension of GPRS technology (EDGE is also called for EGPRS - Enhanced GPRS), with enhanced radio interface allowing triple throughput (in most of current systems up to 236.8 kbit/s) and dynamic adjustment of packet transmission speed depending on transmission conditions.

13.1.5. UMTS

Universal Mobile Telecommunications System (**UMTS**) is a system of third generation cellular phone networks following 2G systems like GSM. The new radio interface significantly improved data transfer between the subscriber and the network boosting the quality of service (384 kbit/s throughput).

13.1.6. HSDPA

HSDPA (High Speed Downlink Packet Access) is a technology based on shared transmission channel. The main feature is dynamic adaptation to changes in radio environment and quick retransmission of faulty data. The HSDPA technology allows transmission from the network to device with 14,4 Mb/s speed.

13.2. Application examples

This chapter shows basic configurations of systems employing MT-101 modules.

13.2.1. Communication with single module

This is the simplest possible monitoring system based on transmission of SMS messages by MT modules in case of event defined during module configuration. In this mode, the module sends text SMS with static or dynamic content holding information on input/output states or content of module's internal registers. This mode may be employed in systems where continuous monitoring is not imperative but alert when defined event occurs or an answer for enquiry is wanted. SMS syntax is described in appendices.



In this system, the MT-101 module set to Modbus RTU Mirror mode can be used. The module generates events based on data read from slave device connected to PORT 2 and mirrored into modules internal registers. This method significantly extends the number of inputs/outputs responsible for generation of events

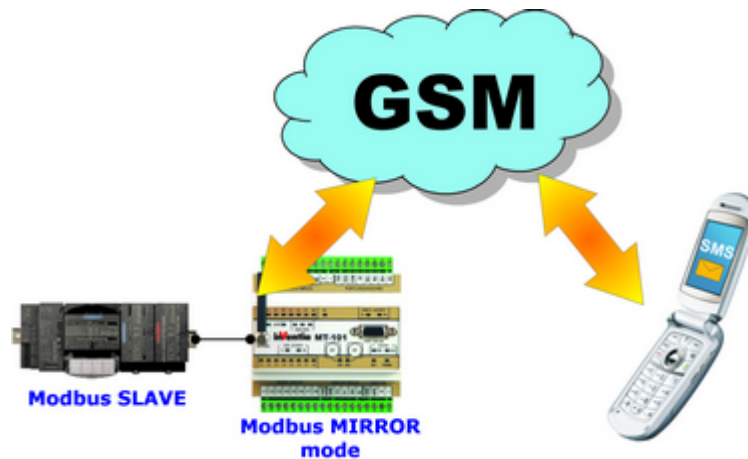

13.2.2. Point to point communication

This is a basic minimal configuration enabling data transmission between two devices. In this configuration, one can access internal module resources, discrete resources (inputs/outputs) or access resources of a device connected to module's serial port or mixed access to all above mentioned.

13.2.2.1. Using internal resources

This configuration requires two MT-101 modules, where one acts as a gateway to a transmission system (PLC, SCADA) set in Modbus Master mode. In this case, the device connected to MT-101 plays the role as master, sending inquiries about appropriate resources of remote MT-101 module. The module connected to a master gives access to its internal resources thus widening the central system.

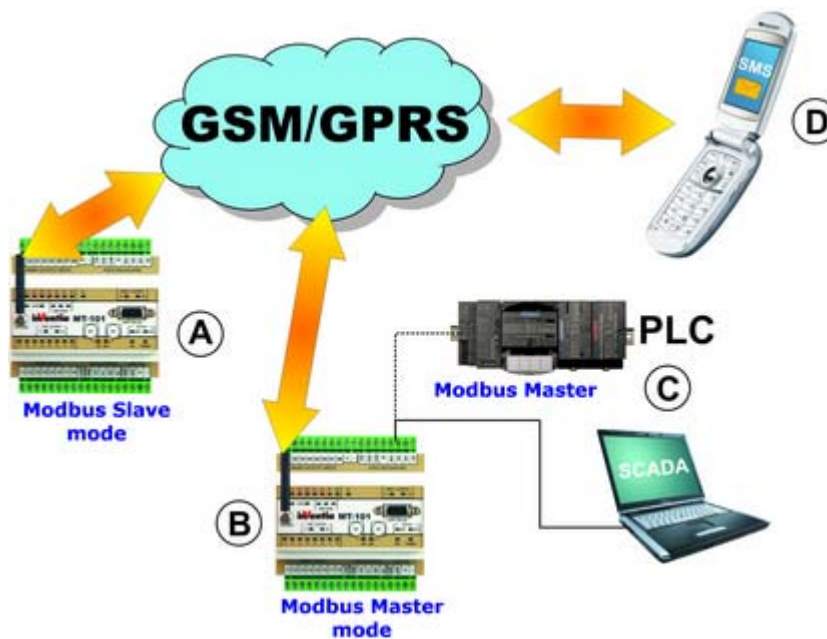

Internal configuration of modules is as follows:

Module (A)

Set Module operating mode to Modbus RTU Slave or MT Slave

Set Modbus ID number of the module to a value different than zero (f.e.1)

Set Authorized IP to 1 and add the IP assigned to module MT-101 operating in Modbus RTU Master mode (options allowing data transmission and reception have to be checked in).

Module (B)

Set Module operating mode to Modbus RTU Master

Set Modbus ID number of the module to a value different than zero (f.e.2)

Set Authorized IP to 1 and add the IP assigned to module MT-101 operating in Modbus RTU Master mode (options allowing data transmission and reception have to be checked in).

Fill in the Routing table setting IP address and Modbus ID assigned to MT-101 operating in Modbus RTU Slave (or MT Slave) mode.

The device playing role of master (C) should be connected to PORT 2 of module (B) and query resources of address assigned to module Slave (A). The master can query module (B) provided that Modbus address of module (B) is sent along.

A system configured this way secures permanent access to all internal resources of the Slave including SMS services in situations defined during configuration. If the master unit is a PC running on Windows, the MT Data Provider (OPC Server) delivered with the module is the best solution for communication. MT Data Provider serves both querying and unsolicited messaging on the basis of Data sending rules defined during modules configuration.

Access to internal resources of modules in a telemetry network is similar to that described above. The only difference is the number of network nodes and assignment of unique Modbus IDs necessary for precise addressing of queries associated with it. Remember to put all slaves IP addresses into Master module's IP list along with corresponding Modbus ID and make sure that reading and writing is enabled.

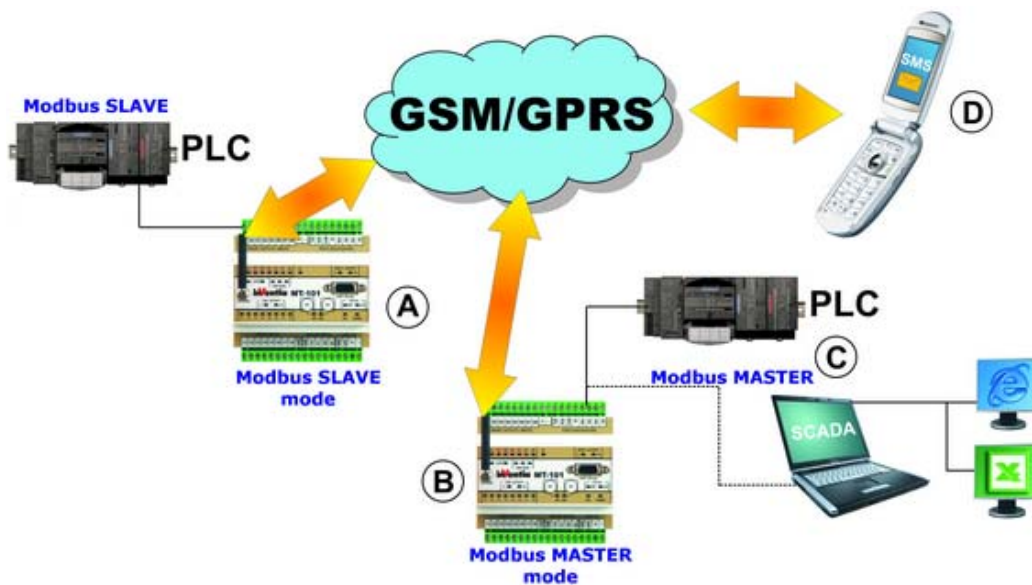

13.2.2.2. Data transmission from external devices

13.2.2.2.1. Configuration for transparent mode

Transparent mode does not require any configuration of internal resources. In this mode, all data arriving at PORT2 will be transmitted in accordance with recipients defined in IP number list as allowing transmission. One has to notice that queries are not routed to a particular telemetry module with attached slave but sent to all devices in the system without decoding of protocol. This allows for transmission of data in unknown protocol but increases costs of transmission since data is sent unselectively. Reduction of transmission expenses is possible only by employing the function of transmission channel reservation.

13.2.2.2.2. Configuration for GazModem mode

The system consisting of MT-101 modules in GazModem mode integrates dispersed objects in gas metering systems equipped with electronic counters into centralized measuring system.

After setting configuration parameters and connecting of device to PORT 2 of the module, the user obtains access to current data and alarms stored continuously in module memory. In this setup, MT-101 module may act as a concentrator for 16 devices.



13.2.2.2.3. Configuration for M-Bus Lec mode

The system consisting of MT-101 modules in Mbus LEC mode integrates dispersed objects in heat consumption metering systems equipped with electronic counters into a centralized measuring system. After setting configuration parameters and connecting of device to PORT 2 of the module, the user obtains access to current data and possibility of defining alarm thresholds continuously stored in module memory. In this setup, MT-101 module may act as a concentrator for 16 devices. Additionally, in this mode connection of PORT1 to an auxiliary counter serving in Gaz-Modem protocol is possible.

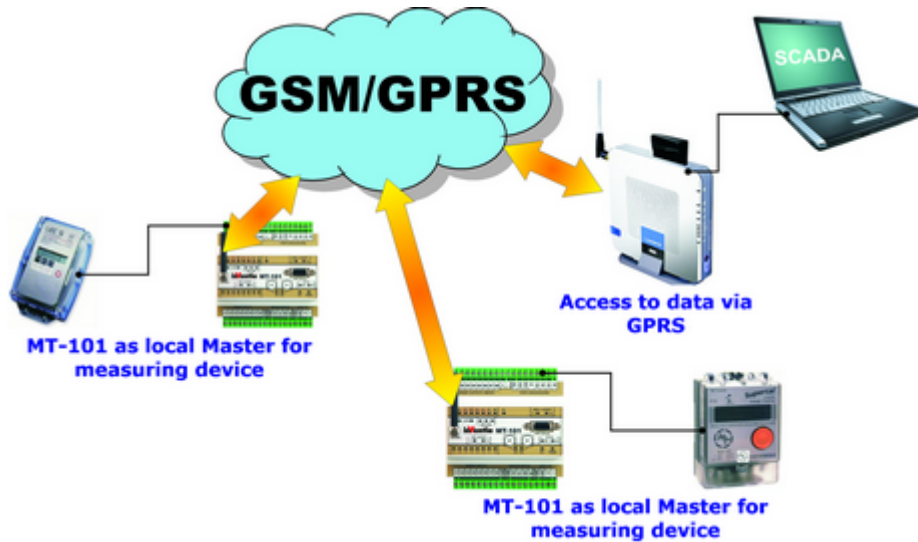

13.2.2.2.4. Configuration for NMEA 0183 mode

In NMEA 0183 mode, MT-101 module monitors information delivered by weather stations like AIRMAR to PORT 2, which is stored in register memory space. Beyond localization parameters from integrated GPS Receiver, AIRMAR station delivers parameters like: temperature, pressure, humidity, speed and direction of wind. Full range of variables delivered by this device is to be found in chapter additional resources for NMEA 0183 mode.

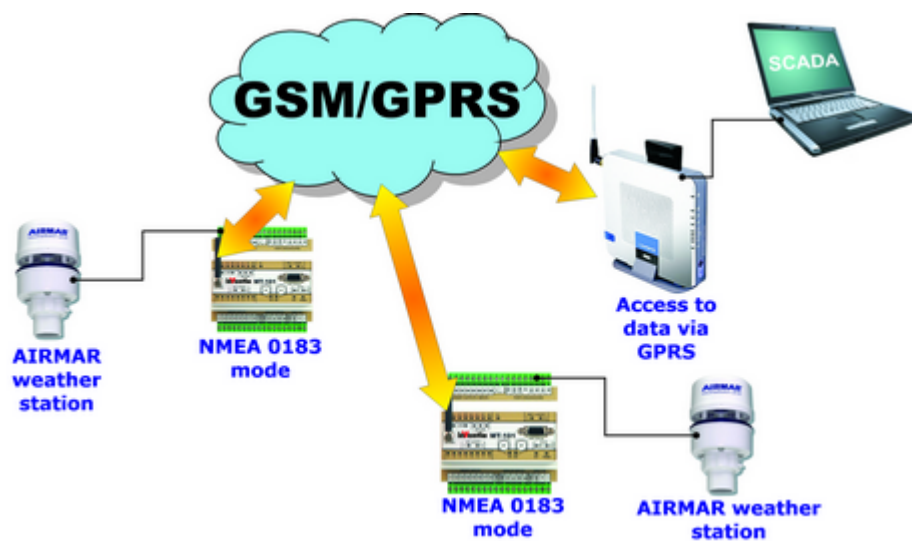

13.3. Syntax for reading and writing data in SMS mode

Basic syntax:

Reading

#[representation][internal resource]/[% space address]

Writing

#[representation][internal resource]/[% space address]=value

The value may be variable or constant. It is for example possible to send an SMS resulting in assigning the state of I1 to Q1 (#Q1=I1 or #Q1=#I1). Using second form replaces #I1 with the current value f.e. #Q1=1. In first version the proper execution will be confirmed with identical syntax.

Value representation (the way of displaying or interpreting of the value)

D or none decimally
H hexadecimally (for registers always in four digits f.e. 002F)
B binary (for registers always in 16 digits f.e. 0000000000010111)
S string (read only). Presents ASCII text stored in registers. NULL (0x0000) character should be used as end of string marker.

Internal resource

Ix state of input Ix, x in range 1...8
Qx state of output Qx, x in range 1...8
Anx analogue input, x in range 1...2

% space address - access to internal variables

I - bits in binary inputs space
Q - bits in binary outputs space
AI - Input Registers (16 bit)
R - Internal Registers (16 bit)
M - Internal flags (Not deleted and zeroed during module reset)
S - Internal flags (deleted and zeroed during module reset)

Examples of syntax that may along with simple text be a part of the SMS.

#I3	state of terminal I3
#DQ5	state of terminal Q5
#AN1	value of analogue input AN1 decimally
#BAN2	value of analogue input AN2 binary
##R15	value of Register 15 decimally
#H%AI4	value of Input Register 4
##M123	value of M123 flag
#H%R80#H%R81	value of 32 bit Register DREG1 (memory map) 16 bit
#Q1=1	activation of output Q1
##R70=255	setting Register R70 to value of 255
#H%R70=FF	setting Register R70 to value 255
##R1000=2	faulty resource address, replay „Err“

#%R70=100000	faulty value, reply #%R70=Err
#S%R64	text coded in ASCII beginning in internal register which address is 64 decimally and ending in first following register with NULL sign (0x0000).

An example of SMS composed by the user may look as follows:

„State on input Pomp 1 - #I3”

„Coolant temperature - #AN1”

or take other form, consisting of fixed and variable content dependent on variable registers values.

Notice:

- Valid syntax will be replaced in received SMS with current value of particular variable or else unchanged text will be returned.
- One SMS may read several variables.
- If length of received SMS (text + length of variables replacing mnemonics) exceeds 160 characters, (along with time stamp and optional status) the SMS will be truncated so that it ends with time stamp and optional status.
- Syntax is not case sensitive.
- Addresses in commands should be in decimal notation.
- 32 bit Registers occupy two cells in 16 bit register space. Access to 32 bit registers goes through 16 bit Registers.
- Commands modifying internal resources values are executable only for received SMS.
- Upon reception of SMS starting with \$ sign activates "silent mode" and no confirmation is sent to originator.
- Confirmation SMS starts with '>' sign.

13.4. Unlocking writing to internal registers

Procedure when data writing protection is set to Yes :

When data overwriting protection option is set, the module does not process frames trying to change internal resources. Unblocking requires sending data along with password. If received frame contents a valid password, the module allows remote modification of internal resources for 5 minutes or until it receives a frame with empty or invalid password.

Command format:

module's ID (1 byte)	command code (3 bytes)	Password (n bytes)	Password end (1 byte)	Modbus CRC (2 bytes)
ID	0x71, 0x06 0x00	Password text	0x00	CRC_L, CRC_H

Example:

Module settings

ID=5

Password="ABCDE"

HEX: 0x05, 0x71, 0x06, 0x00, 'A', 'B', 'C', 'D', 'E', 0x00, 0x98, 0x70

Decimally: 5, 113, 6, 0, 'A', 'B', 'C', 'D', 'E', 0, 152, 112

13.5. Working with dynamic IP addressing

In order to configure MT-101 module to work in Proxy mode do following:

- In MTManager select Data frame format: Proxy
- Set Proxy server IP: has to be static, public IP address of central (receiving) computer
- In Authorized IP numbers type the serial number 255.255.255.255

The structure of configuration file for MT DataProvider for Proxy mode:

```
<?xml version="1.0"?>
<opc>

<configure net_mode="dynamic" udp_port="7110" timestamp="system"
csv_log="true" csv_path="C:\\" debug="true"/>

<network name="mt101"
udp_port=""
ip_receiver=""
ip_header_receiver="011.004.006.002"
ip_header_sender="255.255.255.255"
timeout="10" retries="4" add_crc="true"
csv_msg_log="true" debug="false" enable="true">

<modbus name="id13" id="13" type="registers" address="0"
size="5" interval="25" debug="false" enable="true"/>

<modbus name="id13" id="13" type="binary_inputs" address="8"
size="8" interval="25" debug="false" enable="true"/>

<modbus name="id13" id="13" type="binary_outputs" address="0"
size="8" interval="25" debug="false" enable="true"/>

</network>
</opc>

comment:
<!-- udp_port="" port assigned when remote module reports-->
<!-- ip_receiver="" IP assigned when remote module reports-->
<!-- ip_header_receiver="011.004.006.002" serial number of remote module-->
<!-- ip_header_sender="255.255.255.255" serial number of computer with public, static IP
]-->
```

13.6. Data formats

MT-101 module gives the user a choice of data frame format :

- standard - standard operating mode. The units communicate directly with each other in the APN using static IP addresses allocated permanently to used SIM cards. In this mode, IP addresses of communicating modules are written into authorized units lists.
- Open - The same configuration as standard. The only difference is lack of frame protection and opened header format of UDP frame allowing the user to create his own user access system.

UDP data frame format (port 7110)

Header			Data block
Frame identifier 16 bit, 2 bytes (H,L)	Data block size in bytes, 2 bytes (H,L)	Frame identifier 16 bit, 2 bytes (H,L)	Dane

1. Frame identifier is used for data flow control, f.e. elimination of repeated frames. When sending consecutive data frames, this number shall be incremented.
2. Max. data block size is 1408 bytes.
3. For access to the module MODBUS frames are used. They are placed in data block without ending CRC.

Data block (MODBUS frame)		
Unit ID (1 byte)	Unit ID (1 byte)	Unit ID (1 byte)

4. Upon reception of correct data frame the sender has to be informed by a receipt in a form of an UDP frame bearing only the header of received frame.
- Proxy - In this configuration, units communicate with each other through an external server. The server IP is written in Proxy server IP configuration variable. This mode allows using modules with SIM cards without assigned static address. Modules receive a randomly selected IP address during network login procedure. The Module establishes communication (sends and receives packets) only with Proxy server. Since modules in this mode are identified by serial numbers tables and lists describing, other modules in the network hold serial numbers instead of IP addresses. Dynamically addressed modules do not have the possibility of remote configuration or remote programming.
 - UDP Standard - in this data module communicates using the Modbus frame encapsulated in standard UDP frame. This allows user to use Modbus/UDP drivers provided from other companies, but disables data delivery control system (confirmation of correct data frame reception mechanism). GPRS transmission retries number and GPRS transmission timeout parameters are unavailable in that operating mode.

13.7. Module's Status format

Status frame of MT-101 module is a sequence of four 16 bit registers from internal registers space (read command 03H, write 06H or 10H).

0x03E4	Inputs space	MT_IN	I8..I1	IQ8..IQ1
0x03E5	Outputs space	MT_OUT	0..0	Q8..Q1
0x03E6	AN1 input (copy input Register 0x0004)	MT_AN1	16 bit value	
0x03E7	AN2 input (copy of input Register 0x0005)	MT_AN2	16 bit value	

A call upon this coherent area in memory gives optimal access to all physical inputs/outputs of MT-101.

The same area is used for status sending.

SMS length and status may not exceed 160 characters. If longer, the text is truncated and complete status is sent.

<message text>

<module status>

<time stamp>

where status is:
 I1...I8=01101011
 Q1...Q8=01101011
 AN1=143
 AN2=1780

Binary values are represented bitwise.
 Analogue values are represented in engineering units

13.8. Trigger inputs

During operation, the internal system of **MT-101** module creates a number of variables related to its inputs/outputs and to module diagnostics. Triggering inputs and triggering flags in conjunction with rules processing enable instantaneous reaction in occurring states.

User has access to following triggering inputs:

input	Description
I1...I8	binary inputs I1...I8
Q1...Q8	binary inputs/outputs Q1...Q8
A1, A2	Analogue inputs A1, A2
FS1_ups	= 1, no voltage on UPS pin
FS1_q+	= 1, no supply for binary outputs Q1...Q8
FS1_gprs	= 1, information of logging out of GPRS network
P1...P32	Program flags P1...P32 (definable in user program)
TMR1...TMR4	flags from Asynchronous clocks TMR1,TMR2 and synchronous TMR3, TMR4

13.9. Flags

During operation **MT-101** module governs a number of binary flags (assuming value *True* or *False*) that trigger rules processing and remote diagnostics.

The User has access to following flags:

Flag	resources attached	Description
Bi In 0->1	Binary inputs I1...I8, Q1...Q8	Flag assuming value <i>True</i> after change of binary input from 0 to 1
Bi In 1->0	Binary inputs I1...I8, Q1...Q8	Flag assuming value <i>True</i> after change of binary input from 1 to 0
Bi In Chg	Binary inputs I1...I8, Q1...Q8	Flag assuming value <i>True</i> after any change of binary input
Bi Out Err	Binary outputs. Q1....Q8	Flag assuming value <i>True</i> if read outputs state does not comply with set state
Counter	Binary inputs I1...I8, Q1...Q8	Flag assuming value <i>True</i> when counter reaches set value or zero value (depending on counting direction)

An LoLo	Analogue inputs I1...I8 Q1...Q8 A1, A2	Flag assuming value <i>True</i> if value of analogue input is lower than value set as Alarm LoLo(preserving relation to hysteresis)
An Lo	Analogue inputs I1...I8 Q1...Q8 A1, A2	Flag assuming value <i>True</i> if value of analogue input is lower than value set as Alarm Lo(preserving relation to hysteresis)
An Hi	Analogue inputs I1...I8 Q1...Q8 A1, A2	Flag assuming value <i>True</i> if value if value of analogue input is higher than value set as Alarm Hi(preserving relation to hysteresis)
An HiHi	Analogue inputs I1...I8 Q1...Q8 A1, A2	Flag assuming value <i>True</i> if value of analogue input is higher than value set as Alarm HiHi(preserving relation to hysteresis)
An DB	Analogue inputs I1...I8 Q1...Q8 A1, A2	Flag assuming value <i>True</i> if value of analogue input crosses defined deviation of previous central value
AN Set Rise	Analogue inputs A1, A2	Flag assuming value <i>True</i> if value if value of analogue input is higher than value set as threshold with SET button on front panel (preserving relation to hysteresis)
AN Set Fall	Analogue inputs A1, A2	Flag assuming value <i>True</i> if value if value of analogue input is lower than value set as threshold with SET button on front panel (preserving relation to hysteresis)

13.10. RM-120

Converter module **RM-120** is used as an intermediate in communication between telemetry module and the heat meter employing M-BUS transmission protocol. RM-120 performs the conversion of RS-232 signal to electrical M-Bus signal.



Terminal	Description
+ (Mbus)	Pin + M-Bus
- (Mbus)	Pin - M-Bus
PE2	ground for M-Bus circuit
- (24-36VDC)	converter module power supply (pin -)
+ (24-36VDC)	converter module power supply (pin +)
TXD	RS232 sender output
RXD	RS232 sender input
COM	RS232 circuit ground
RTS	optional signaling for computers COM connection (not used for MT module)
PE1	RS232 circuit ground

13.11. Memory map

13.11.1. Binary inputs space

Binary inputs (bit addressable - command 02)

Address	+ 0	+ 1	+ 2	+ 3	+ 4	+ 5	+ 6	+ 7	Description	Virtual Registers
0x0000	IQ1	IQ2	IQ3	IQ4	IQ5	IQ6	IQ7	IQ8	Pin state Q1...Q8	VREG_BIO
0x0008	I1	I2	I3	I4	I5	I6	I7	I8	Pin state I1...I8	
0x0010	ERR_Q1	ERR_Q2	ERR_Q3	ERR_Q4	ERR_Q5	ERR_Q6	ERR_Q7	ERR_Q8	Error messages for outputs Q1..Q8	VREG_BI1
0x0018	AN1_LoLo	AN1_Lo	AN1_Hi	AN1_HiHi	AN1_Set_F	AN1_Set_R	AN1_Dbd	0	Threshold bits for analog input AN1 + dead band cross over	
0x0020	AN2_LoLo	AN2_Lo	AN2_Hi	AN2_HiHi	AN2_Set_F	AN2_Set_R	AN2_Dbd	0	Threshold bits for analog input AN2 + dead band cross over	VREG_BI2
0x0028	FS1_fs	FS1_ovr	FS1_ups	FS1_q+	FS1_prog	FS1_gprs	FS1_event	FS1_sms	<p>FS1_fs = 1 - first cycle of the program</p> <p>FS1_ovr = 1 - delayed cycle start (previous cycle longer than 100ms)</p> <p>FS1_ups = 1 - no supply on UPS pin</p> <p>FS1_q+ = 1 - no supply for binary outputs Q1..Q8</p> <p>FS1_prog = 1 - error detected in user's program, program stopped.</p> <p>FS1_gprs = 1 - module logged out of GPRS. On logon the bit is reset. On power on FS1_gprs = 0</p> <p>FS1_event = 1 - event queue overflow - data</p> <p>FS1_sms = 1 - event queue overflow - SMS</p>	

0x0030	F_CNT_Q1	F_CNT_Q2	F_CNT_Q3	F_CNT_Q4	F_CNT_Q5	F_CNT_Q6	F_CNT_Q7	F_CNT_Q8	Counter flip over for inputs Q1..Q8	VREG_BI3
0x0038	F_CNT_I1	F_CNT_I2	F_CNT_I3	F_CNT_I4	F_CNT_I5	F_CNT_I6	F_CNT_I7	F_CNT_I8	Counter flip over for inputs I1..I8	
0x0040	C1	C2	C3	C4	C5	C6	C7	C8	Counter outputs C1 .. C8	VREG_BI4
0x0048	T1	T2	T3	T4	T5	T6	T7	T8	Timer outputs T1 .. T8	
0x0050	AQ1_LoLo	AQ1_Lo	AQ1_Hi	AQ1_HiHi	AI1_LoLo	AI1_Lo	AI1_Hi	AI1_HiHi	Threshold bits for frequency analog inputs AQ1 and AI1	VREG_BI5
0x0058	AQ2_LoLo	AQ2_Lo	AQ2_Hi	AQ2_HiHi	AI2_LoLo	AI2_Lo	AI2_Hi	AI2_HiHi	Threshold bits for frequency analog inputs AQ2 and AI2	
0x0060	AQ3_LoLo	AQ3_Lo	AQ3_Hi	AQ3_HiHi	AI3_LoLo	AI3_Lo	AI3_Hi	AI3_HiHi	Threshold bits for frequency analog inputs AQ3 and AI3	VREG_BI6
0x0068	AQ4_LoLo	AQ4_Lo	AQ4_Hi	AQ4_HiHi	AI4_LoLo	AI4_Lo	AI4_Hi	AI4_HiHi	Threshold bits for frequency analog inputs AQ4 and AI4	
0x0070	AQ5_LoLo	AQ5_Lo	AQ5_Hi	AQ5_HiHi	AI5_LoLo	AI5_Lo	AI5_Hi	AI5_HiHi	Threshold bits for frequency analog inputs AQ5 and AI5	VREG_BI7
0x0078	AQ6_LoLo	AQ6_Lo	AQ6_Hi	AQ6_HiHi	AI6_LoLo	AI6_Lo	AI6_Hi	AI6_HiHi	Threshold bits for frequency analog inputs AQ6 and AI6	
0x0080	AQ7_LoLo	AQ7_Lo	AQ7_Hi	AQ7_HiHi	AI7_LoLo	AI7_Lo	AI7_Hi	AI7_HiHi	Threshold bits for frequency analog inputs AQ7 and AI7	VREG_BI8
0x0088	AQ8_LoLo	AQ8_Lo	AQ8_Hi	AQ8_HiHi	AI8_LoLo	AI8_Lo	AI8_Hi	AI8_HiHi	Threshold bits for frequency analog inputs AQ8 and AI8	
0x0090	AQ1_Dbd	AQ2_Dbd	AQ3_Dbd	AQ4_Dbd	AQ5_Dbd	AQ6_Dbd	AQ7_Dbd	AQ8_Dbd	Dead band cross over bits for frequency analog inputs. AQ1..AQ8	VREG_BI9
0x0098	AI1_Dbd	AI2_Dbd	AI3_Dbd	AI4_Dbd	AI5_Dbd	AI6_Dbd	AI7_Dbd	AI8_Dbd	Dead band cross over bits for frequency analog inputs. AI1..AI8	
0x00A0	TMR1	TMR2	TMR3	TMR4	0	0	0	0	User defined timer flip over info	VREG_BI10
0x00A8	SL1_ok	SL2_ok	SL3_ok	SL4_ok	SL5_ok	SL6_ok	SL7_ok	SL8_ok	Serial communication status bits for Modbus Mirror, Macmat Slave GazModem and M-Bus LEC modes	
0x00B0	SL9_ok	SL10_ok	SL11_ok	SL12_ok	SL13_ok	SL14_ok	SL15_ok	SL16_ok	Serial communication status bits for Modbus Mirror mode	

0x00B8	---	---	---	---	---	---	---	---	---	---	---
...											...
0x02B0	---	---	---	---	---	---	---	---	---	---	VREG_BI43
0x02B8	MT2MT_1	MT2MT_2	MT2MT_3	MT2MT_4	MT2MT_5	MT2MT_6	MT2MT_7	MT2MT_8			VREG_BI44
0x02C0	MT2MT_9	MT2MT_10	MT2MT_11	MT2MT_12	MT2MT_13	MT2MT_14	MT2MT_15	MT2MT_16			VREG_BI45
0x02C8	MT2MT_17	MT2MT_18	MT2MT_19	MT2MT_20	MT2MT_21	MT2MT_22	MT2MT_23	MT2MT_24			VREG_BI46
0x02D0	MT2MT_25	MT2MT_26	MT2MT_27	MT2MT_28	MT2MT_29	MT2MT_30	MT2MT_31	MT2MT_32			VREG_BI47
0x02D8	MT2MT_33	MT2MT_34	MT2MT_35	MT2MT_36	MT2MT_37	MT2MT_38	MT2MT_39	MT2MT_40			VREG_BI48
0x02E0	MT2MT_41	MT2MT_42	MT2MT_43	MT2MT_44	MT2MT_45	MT2MT_46	MT2MT_47	MT2MT_48			VREG_BI49
0x02E8	MT2MT_49	MT2MT_50	MT2MT_51	MT2MT_52	MT2MT_53	MT2MT_54	MT2MT_55	MT2MT_56			VREG_BI50
0x02F0	MT2MT_57	MT2MT_58	MT2MT_59	MT2MT_60	MT2MT_61	MT2MT_62	MT2MT_63	MT2MT_64			VREG_BI51
0x02F8	MT2MT_65	MT2MT_66	MT2MT_67	MT2MT_68	MT2MT_69	MT2MT_70	MT2MT_71	MT2MT_72			VREG_BI52
0x0300	MT2MT_73	MT2MT_74	MT2MT_75	MT2MT_76	MT2MT_77	MT2MT_78	MT2MT_79	MT2MT_80			VREG_BI53
0x0308	MT2MT_81	MT2MT_82	MT2MT_83	MT2MT_84	MT2MT_85	MT2MT_86	MT2MT_87	MT2MT_88			VREG_BI54
0x0310	MT2MT_89	MT2MT_90	MT2MT_91	MT2MT_92	MT2MT_93	MT2MT_94	MT2MT_95	MT2MT_96			
0x0318	MT2MT_97	MT2MT_98	MT2MT_99	MT2MT_100	MT2MT_101	MT2MT_102	MT2MT_103	MT2MT_104			
0x0320	MT2MT_105	MT2MT_106	MT2MT_107	MT2MT_108	MT2MT_109	MT2MT_110	MT2MT_111	MT2MT_112			
0x0328	MT2MT_113	MT2MT_114	MT2MT_115	MT2MT_116	MT2MT_117	MT2MT_118	MT2MT_119	MT2MT_120			
0x0330	MT2MT_121	MT2MT_122	MT2MT_123	MT2MT_124	MT2MT_125	MT2MT_126	MT2MT_127	MT2MT_128			
0x0338	MT2MT_129	MT2MT_130	MT2MT_131	MT2MT_132	MT2MT_133	MT2MT_134	MT2MT_135	MT2MT_136			
0x0340	MT2MT_137	MT2MT_138	MT2MT_139	MT2MT_140	MT2MT_141	MT2MT_142	MT2MT_143	MT2MT_144			
0x0348	MT2MT_145	MT2MT_146	MT2MT_147	MT2MT_148	MT2MT_149	MT2MT_150	MT2MT_151	MT2MT_152			
0x0350	MT2MT_153	MT2MT_154	MT2MT_155	MT2MT_156	MT2MT_157	MT2MT_158	MT2MT_159	MT2MT_160			
0x0358	MT2MT_161	MT2MT_162	MT2MT_163	MT2MT_164	MT2MT_165	MT2MT_166	MT2MT_167	MT2MT_168			
0x0360	MT2MT_169	MT2MT_170	MT2MT_171	MT2MT_172	MT2MT_173	MT2MT_174	MT2MT_175	MT2MT_176			
0x0368	MT2MT_177	MT2MT_178	MT2MT_179	MT2MT_180	MT2MT_181	MT2MT_182	MT2MT_183	MT2MT_184			

Bits informing about MT2MT buffer modification with values received with unsolicited messages. The bit number corresponds to the sender's index in Authorized numbers table in the module's configuration, thus referring to the sending module's IP address. Bits are set for one program cycle.

0x0370	MT2MT_18 5	MT2MT_18 6	MT2MT_18 7	MT2MT_18 8	MT2MT_189	MT2MT_190	MT2MT_19 1	MT2MT_19 2		VREG_BI55
0x0378	MT2MT_19 3	MT2MT_19 4	MT2MT_19 5	MT2MT_19 6	MT2MT_197	MT2MT_198	MT2MT_19 9	MT2MT_20 0		VREG_BI56
0x0380	MT2MT_20 1	MT2MT_20 2	MT2MT_20 3	MT2MT_20 4	MT2MT_205	MT2MT_206	MT2MT_20 7	MT2MT_20 8		VREG_BI57
0x0388	MT2MT_20 9	MT2MT_21 0	MT2MT_21 1	MT2MT_21 2	MT2MT_213	MT2MT_214	MT2MT_21 5	MT2MT_21 6		VREG_BI58
0x0390	MT2MT_21 7	MT2MT_21 8	MT2MT_21 9	MT2MT_22 0	MT2MT_221	MT2MT_222	MT2MT_22 3	MT2MT_22 4		VREG_BI59
0x0398	MT2MT_22 5	MT2MT_22 6	MT2MT_22 7	MT2MT_22 8	MT2MT_229	MT2MT_230	MT2MT_23 1	MT2MT_23 2		
0x03A0	MT2MT_23 3	MT2MT_23 4	MT2MT_23 5	MT2MT_23 6	MT2MT_237	MT2MT_238	MT2MT_23 9	MT2MT_24 0		
0x03A8	MT2MT_24 1	MT2MT_24 2	MT2MT_24 3	MT2MT_24 4	MT2MT_245	MT2MT_246	MT2MT_24 7	MT2MT_24 8		
0x03B0	MT2MT_24 9	MT2MT_25 0	MT2MT_25 1	MT2MT_25 2	MT2MT_253	MT2MT_254	MT2MT_25 5	MT2MT_25 6		
0x03B8	---	FS2_apn	0	0	0	0	FS2_new	FS2_stop	<p>FS2_new - informs on downloading of new program. This flag is reset at every program stop or power up.</p> <p>FS2_stop - Informs that program was stopped. This flag is reset only on power up or download of new program.</p> <p>FS2_apn - 1 reflects APN login state, 0 - logged out</p>	VREG_BI59

13.11.2. Binary outputs space

Binary inputs (bit addressable - command 02)

Address	+ 0	+ 1	+ 2	+ 3	+ 4	+ 5	+ 6	+ 7	Description	Virtual registers
0x0000	Q1	Q2	Q3	Q4	Q5	Q6	Q7m	Q8	bits controlling outputs Q1..Q8 (forcings)	
0x0008	P1	P2	P3	P4	P5	P6	P7	P8	Program flags enabling rule based data transmission on event.	
0x0010	P9	P10	P11	P12	P13	P14	P15	P16		
0x0018	CLK_C1	CLK_C2	CLK_C3	CLK_C4	CLK_C5	CLK_C6	CLK_C7	CLK_C8	Counting inputs C1..C8 (raising edge)	VREG_BO1
0x0020	RST_C1	RST_C2	RST_C3	RST_C4	RST_C5	RST_C6	RST_C7	RST_C8	Counter resetting inputs C1..C8 (active state 1)	VREG_BO2
0x0028	EN_T1	EN_T2	EN_T3	EN_T4	EN_T5	EN_T6	EN_T7	EN_T8	Strobe inputs for timers T1..T8 (active state 1)	
0x0030	RST_T1	RST_T2	RST_T3	RST_T4	RST_T5	RST_T6	RST_T7	RST_T8	Reset inputs for timers T1..T8 (active state 1)	VREG_BO3
0x0038	PS1_stop	MLOG_act	GPRS_data	MLOG_rd	P2RCV_err	P2SND_err	x	x	PS1_stop = 1 - Program stop MLOG_act = 1 - activate MiniLogger GPRS_data - bit set at every reception of a data frame via GPRS MLOG_rd = 1 - force MiniLogger readout, reset after readout P2RCV_err = 1 - byte reception error (f.e. transmission parameter or buffer overflow), reset by user program. P2SND_err = 1 - buffer transmission error (f.e. wrong size), reset by user program.	
0x0040	P17	P18	P19	P20	P21	P22	P23	P24	Program flags enabling rule based data transmission on event.	
0x0048	P25	P26	P27	P28	P29	P30	P31	P32		
0x0050	BU80	BU81	BU82	BU83	BU84	BU85	BU86	BU87	General purpose user fags	VREG_BO5
0x0058	BU88	BU89	BU90	BU91	BU92	BU93	BU94	BU95	General purpose user fags	
...									General purpose user fags	
0x00F0	BU240	BU241	BU242	BU243	BU244	BU245	BU246	BU247	General purpose user fags	VREG_BO15
0x00F8	BU248	BU249	BU250	BU251	BU252	BU253	BU254	BU255	General purpose user fags	

13.11.3. Analogue inputs space

Input Registers (16 bit - command 04H)

Address	Description	Symbol
0x0000	analogue input AN1 (converter directly after averaging)	
0x0001	analogue input AN2 (converter directly after averaging)	
0x0002	analogue input AN1 (calibrated value in range 4..20 mA - 16 bit value)	16 bit value
0x0003	analogue input AN2 (calibrated value in range 4..20 mA - 16 bit value)	16 bit value
0x0004	analogue input AN1 (engineering units)	AN1
0x0005	analogue input AN2 (engineering units)	AN2
0x0006	RTC - seconds (00..59)	RTC_Sec
0x0007	RTC - minutes (00..59)	RTC_Min
0x0008	RTC - hours (00..23)	RTC_Hour
0x0009	RTC - day of week (1 - Sunday, 7 - Saturday)	RTC_DofW
0x000A	RTC - day of month (1..31)	RTC_Day
0x000B	RTC - month (1..12)	RTC_Mon
0x000C	RTC - year (2000 ... 2099)	RTC_Year
0x000D	Number of sent bytes for GPRS since power up (32 bit unsigned value)	(high 16 bit)
0x000E		(low 16 bit)
0x000F	Number of received bytes for GPRS since power up (32 bit unsigned value)	(high 16 bit)
0x0010		(low 16 bit)
0x0011	Converter F/U - 0...2kHz - Pin Q1	16 bit value
0x0012	Converter F/U - 0...2kHz - Pin Q2	16 bit value
0x0013	Converter F/U - 0...2kHz - Pin Q3	16 bit value
0x0014	Converter F/U - 0...2kHz - Pin Q4	16 bit value
0x0015	Converter F/U - 0...2kHz - Pin Q5	16 bit value
0x0016	Converter F/U - 0...2kHz - Pin Q6	16 bit value
0x0017	Converter F/U - 0...2kHz - Pin Q7	16 bit value
0x0018	Converter F/U - 0...2kHz - Pin Q8	16 bit value
0x0019	Converter F/U - 0...2kHz - Pin I1	16 bit value
0x001A	Converter F/U - 0...2kHz - Pin I2	16 bit value
0x001B	Converter F/U - 0...2kHz - Pin I3	16 bit value
0x001C	Converter F/U - 0...2kHz - Pin I4	16 bit value
0x001D	Converter F/U - 0...2kHz - Pin I5	16 bit value
0x001E	Converter F/U - 0...2kHz - Pin I6	16 bit value
0x001F	Converter F/U - 0...2kHz - Pin I7	16 bit value
0x0020	Converter F/U - 0...2kHz - Pin I8	16 bit value
0x0021	Converter F/U - 0...2kHz - Pin Q1 (engineering units)	AQ1
0x0022	Converter F/U - 0...2kHz - Pin Q2 (engineering units)	AQ2
0x0023	Converter F/U - 0...2kHz - Pin Q3 (engineering units)	AQ3
0x0024	Converter F/U - 0...2kHz - Pin Q4 (engineering units)	AQ4
0x0025	Converter F/U - 0...2kHz - Pin Q5 (engineering units)	AQ5
0x0026	Converter F/U - 0...2kHz - Pin Q6 (engineering units)	AQ6
0x0027	Converter F/U - 0...2kHz - Pin Q7 (engineering units)	AQ7

0x0028	Converter F/U - 0...2kHz - Pin Q8 (engineering units)	AQ8
0x0029	Converter F/U - 0...2kHz - Pin I1 (engineering units)	AI1
0x002A	Converter F/U - 0...2kHz - Pin I2 (engineering units)	AI2
0x002B	Converter F/U - 0...2kHz - Pin I3 (engineering units)	AI3
0x002C	Converter F/U - 0...2kHz - Pin I4 (engineering units)	AI4
0x002D	Converter F/U - 0...2kHz - Pin I5 (engineering units)	AI5
0x002E	Converter F/U - 0...2kHz - Pin I6 (engineering units)	AI6
0x002F	Converter F/U - 0...2kHz - Pin I7 (engineering units)	AI7
0x0030	Converter F/U - 0...2kHz - Pin I8 (engineering units)	AI8
0x0031	---	---
...	...	
0x0070	---	---
0x0072	GPRS statistics- Transmission Number of frames Type 0 (retries not accounted)	(high 16 bits)
0x0073		(low 16 bits)
0x0074	GPRS statistics - Reception Number of retries	(high 16 bits)
0x0075		(low 16 bits)
0x0076	GPRS statistics- Transmission Number of not delivered (not confirmed) frames	(high 16 bits)
0x0077		(low 16 bits)
0x0078	GPRS statistics - Reception Frames Type 0	((high 16 bits)
0x0079		(low 16 bits)
0x007A	GPRS statistics - Reception Frames Type 1	(high 16 bits)
0x007B		(low 16 bits)
0x007C	GPRS statistics - Reception Rejected frames (Type 0) - module busy	(high 16 bits)
0x007D		(low 16 bits)
0x007E	Number of attempts since power up	informing on failed access attempts due to invalid password
0x007F	Last attempt time - Year	
0x0080	Last attempt time - Month	
0x0081	Last attempt time - Day	
0x0082	Last attempt time - hours	
0x0083	Last attempt time - minutes	
0x0084	GSM signal strength (Max value 188)	GSM_SGN_LEV (word)
0x0085	Firmware version (y.xx) y - High byte, xx - Low byte	FIRMWARE_VER (word)
0x0086	Reserved for GAZMODEM extension in MBUS_LEC mode	
...	...	
0x00A7	Reserved for GAZMODEM extension in MBUS_LEC mode	
0x00BC	Number of program lines executed in previous cycle	PRG_CLINE (word)
0x00BD	Elapsed program execution time in previous cycle	PRG_TIME (word)
0x00BE	Help register for function in user program	AUX_RET1 (word)
0x00BF	Help register for function in user program	AUX_RET2 (word)
0x00C0	Parameter 1	PAR_1 (word)
...

0x00FF	Parameter 64	PAR_64 (word)
0x0100	---	---
...
0x01FF	---	---
...
0x0500	Parameter 65	PAR_65 (word)
...
0x053F	Parameter 128	PAR_128 (word)

13.11.4. Internal Registers space

Internal registers space (read command 03H, write 06H or 10H) (Not zeroed at reset)

Address	Description	Symbol	HIGH byte	LOW byte
0x0000	32 bit counter - input Q1	CNT_Q1	(High 16 bits)	
0x0001	32 bit counter - input Q1		(Low 16 bits)	
0x0002	32 bit counter - input Q2	CNT_Q2	(High 16 bits)	
0x0003	32 bit counter - input Q2		(Low 16 bits)	
0x0004	32 bit counter - input Q3	CNT_Q3	(High 16 bits)	
0x0005	32 bit counter - input Q3		(Low 16 bits)	
0x0006	32 bit counter - input Q4	CNT_Q4	(High 16 bits)	
0x0007	32 bit counter - input Q4		(Low 16 bits)	
0x0008	32 bit counter - input Q5	CNT_Q5	(High 16 bits)	
0x0009	32 bit counter - input Q5		(Low 16 bits)	
0x000A	32 bit counter - input Q6	CNT_Q6	(High 16 bits)	
0x000B	32 bit counter - input Q6		(Low 16 bits)	
0x000C	32 bit counter - input Q7	CNT_Q7	(High 16 bits)	
0x000D	32 bit counter - input Q7		(Low 16 bits)	
0x000E	32 bit counter - input Q8	CNT_Q8	(High 16 bits)	
0x000F	32 bit counter - input Q8		(Low 16 bits)	
0x0010	32 bit counter - input I1	CNT_I1	(High 16 bits)	
0x0011	32 bit counter - input I1		(Low 16 bits)	
0x0012	32 bit counter - input I2	CNT_I2	(High 16 bits)	
0x0013	32 bit counter - input I2		(Low 16 bits)	
0x0014	32 bit counter - input I3	CNT_I3	(High 16 bits)	
0x0015	32 bit counter - input I3		(Low 16 bits)	
0x0016	32 bit counter - input I4	CNT_I4	(High 16 bits)	
0x0017	32 bit counter - input I4		(Low 16 bits)	
0x0018	32 bit counter - input I5	CNT_I5	(High 16 bits)	
0x0019	32 bit counter - input I5		(Low 16 bits)	
0x001A	32 bit counter - input I6	CNT_I6	(High 16 bits)	
0x001B	32 bit counter - input I6		(Low 16 bits)	
0x001C	32 bit counter - input I7	CNT_I7	(High 16 bits)	
0x001D	32 bit counter - input I7		(Low 16 bits)	
0x001E	32 bit counter - input I8	CNT_I8	(High 16 bits)	
0x001F	32 bit counter - input I8		(Low 16 bits)	
0x0020	16 bit counter - C1 (threshold value)	PV_C1		16 bit value
0x0021	16 bit counter - C2 (threshold value)	PV_C2		16 bit value
0x0022	16 bit counter - C3 (threshold value)	PV_C3		16 bit value
0x0023	16 bit counter - C4 (threshold value)	PV_C4		16 bit value
0x0024	16 bit counter - C5 (threshold value)	PV_C5		16 bit value
0x0025	16 bit counter - C6 (threshold value)	PV_C6		16 bit value
0x0026	16 bit counter - C7 (threshold value)	PV_C7		16 bit value
0x0027	16 bit counter - C8 (threshold value)	PV_C8		16 bit value
0x0028	16 bit Timer - T1 (threshold value)	PV_T1		16 bit value

0x0029	16 bit Timer - T2 (threshold value)	PV_T2	16 bit value
0x002A	16 bit Timer - T3 (threshold value)	PV_T3	16 bit value
0x002B	16 bit Timer - T4 (threshold value)	PV_T4	16 bit value
0x002C	16 bit Timer - T5 (threshold value)	PV_T5	16 bit value
0x002D	16 bit Timer - T6 (threshold value)	PV_T6	16 bit value
0x002E	16 bit Timer - T7 (threshold value)	PV_T7	16 bit value
0x002F	16 bit Timer - T8 (threshold value)	PV_T8	16 bit value
0x0030	16 bit counter - C1 (current value)	REG_C1	16 bit value
0x0031	16 bit counter - C2 (current value)	REG_C2	16 bit value
0x0032	16 bit counter - C3 (current value)	REG_C3	16 bit value
0x0033	16 bit counter - C4 (current value)	REG_C4	16 bit value
0x0034	16 bit counter - C5 (current value)	REG_C5	16 bit value
0x0035	16 bit counter - C6 (current value)	REG_C6	16 bit value
0x0036	16 bit counter - C7 (current value)	REG_C7	16 bit value
0x0037	16 bit counter - C8 (current value)	REG_C8	16 bit value
0x0038	16 bit Timer - T1 (current value)	REG_T1	16 bit value
0x0039	16 bit Timer - T2 (current value)	REG_T2	16 bit value
0x003A	16 bit Timer - T3 (current value)	REG_T3	16 bit value
0x003B	16 bit Timer - T4 (current value)	REG_T4	16 bit value
0x003C	16 bit Timer - T5 (current value)	REG_T5	16 bit value
0x003D	16 bit Timer - T6 (current value)	REG_T6	16 bit value
0x003E	16 bit Timer - T7 (current value)	REG_T7	16 bit value
0x003F	16 bit Timer - T8 (current value)	REG_T8	16 bit value
0x0040	16 bit Program register (unsigned value)	REG1	16 bit value
0x0041	16 bit Program register (unsigned value)	REG2	16 bit value
0x0042	16 bit Program register (unsigned value)	REG3	16 bit value
0x0043	16 bit Program register (unsigned value)	REG4	16 bit value
0x0044	16 bit Program register (unsigned value)	REG5	16 bit value
0x0045	16 bit Program register (unsigned value)	REG6	16 bit value
0x0046	16 bit Program register (unsigned value)	REG7	16 bit value
0x0047	16 bit Program register (unsigned value)	REG8	16 bit value
0x0048	16 bit Program register (unsigned value)	REG9	16 bit value
0x0049	16 bit Program register (unsigned value)	REG10	16 bit value
0x004A	16 bit Program register (unsigned value)	REG11	16 bit value
0x004B	16 bit Program register (unsigned value)	REG12	16 bit value
0x004C	16 bit Program register (unsigned value)	REG13	16 bit value
0x004D	16 bit Program register (unsigned value)	REG14	16 bit value
0x004E	16 bit Program register (unsigned value)	REG15	16 bit value
0x004F	16 bit Program register (unsigned value)	REG16	16 bit value
0x0050	32 bit Program register (signed value)	DREG1	(High 16 bits)
0x0051			(Low 16 bits)
0x0052	32 bit Program register (signed value)	DREG2	(High 16 bits)
0x0053			(Low 16 bits)
0x0054	32 bit Program register (signed value)	DREG3	(High 16 bits)
0x0055			(Low 16 bits)
0x0056	32 bit Program register (signed value)	DREG4	(High 16 bits)
0x0057			(Low 16 bits)
0x0058	32 bit Program register (signed value)	DREG5	(High 16 bits)
0x0059			(Low 16 bits)
0x005A	32 bit Program register (signed value)	DREG6	(High 16 bits)
0x005B			(Low 16 bits)
0x005C	32 bit Program register (signed value)	DREG7	(High 16 bits)
0x005D			(Low 16 bits)
0x005E	32 bit Program register (signed value)	DREG8	(High 16 bits)
0x005F			(Low 16 bits)
0x0060	16 bit Program register (unsigned value)	XREG1	16 bit value
...

0x025F	16 bit Program register (unsigned value)	XREG512	16 bit value
0x0260	Dead band threshold AQ1	RDBD_AQ1	16 bit value
...
0x0267	Dead band threshold AQ8	RDBD_AQ8	16 bit value
0x0268	Dead band threshold AI1	RDBD_AI1	16 bit value
...
0x026F	Dead band threshold AI8	RDBD_AI8	16 bit value
0x0270	Dead band threshold AN1	RDBD_AN1	16 bit value
0x0271	Dead band threshold AN2	RDBD_AN2	16 bit value

Registers holding last received via GPRS status of remote module				
0x0272	Input space	RMT_IN	I8..I1	IQ8..IQ1
0x0273	Remote module ID + output space	RMT_ID_OUT	ID	Q8..Q1
0x0274	Input AN1	RMT_AN1	16 bit value	
0x0275	Input AN2	RMT_AN2	16 bit value	
...	
0x0280	32 bit activity time counter on input Q1 [s]	CNT_ON_Q1	(High 16 bits)	
0x0281	32 bit activity time counter on input Q1 [s]		(Low 16 bits)	
0x0282	32 bit activity time counter on input Q2 [s]	CNT_ON_Q2	(High 16 bits)	
0x0283	32 bit activity time counter on input Q2 [s]		(Low 16 bits)	
...	
0x028E	32 bit activity time counter on input Q8 [s]	CNT_ON_Q8	(High 16 bits)	
0x028F	32 bit activity time counter on input Q8 [s]		(Low 16 bits)	
0x0290	32 bit activity time counter on input I1 [s]	CNT_ON_I1	(High 16 bits)	
0x0291	32 bit activity time counter on input I1 [s]		(Low 16 bits)	
...	
0x029E	32 bit activity time counter on input I8 [s]	CNT_ON_I8	(High 16 bits)	
0x029F	32 bit activity time counter on input I8 [s]		(Low 16 bits)	

Mirror	Device status - Mirror		HIGH byte	LOW byte
0x03E4	Inputs space	MT_IN	I8..I1	IQ8..IQ1
0x03E5	Outputs space	MT_OUT	0..0	Q8..Q1
0x03E6	Input AN1 (copy of input register 0x0004)	MT_AN1	16 bit value	
0x03E7	Input AN2 (copy of input register 0x0005)	MT_AN2	16 bit value	
Registers for FlexSerial mode data services				
0x03FE	Data size in reception buffer	P2RCV_NO	0..512	
0x03FF	Data size to be sent in do transmission buffer	P2SND_NO	0..512	
0x0400	reception buffer	P2RCV_B1	---	byte 1
0x0401	reception buffer	P2RCV_B2	---	byte 2
...

0x05FF	reception buffer	P2RCV_B512	---	byte 512
0x0600	transmission buffer	P2SND_B1	---	byte 1
0x0601	transmission buffer	P2SND_B2	---	byte 2
...	...			
0x07FF	transmission buffer	P2SND_B512	---	byte 512

RTC	Registers for module time modification (for block writing only, command 0x10)			
0x2700	RTC - seconds (00...59)			16 bit value
0x2701	RTC - minutes (00...59)			16 bit value
0x2702	RTC - hours (00...23)			16 bit value
0x2703	RTC - day of week (1 - Saturday, 7 - Sunday)			16 bit value
0x2704	RTC - day of month (1...31)			16 bit value
0x2705	RTC - month (1...12)			16 bit value
0x2706	RTC - year (2000...2099)			16 bit value
0x2707	RTC - negated bits of RTC registers +1 (protection against accidental RTC settings modification)			16 bit value

13.11.5. Auxiliary resources for GazModem mode

Input registers space

Registers holding signals read from gas counters.

Start Address			Name	Description
hex	dec	MODBUS		
0x31	049	30050	MC1SYG1	High byte - status, Low - signals
0x32	050	30051	MC2SYG1	High byte - status, Low - signals
...
0x40	64	30065	MC16SYG1	High byte - status, Low - signals
0x41	65	30066	MC1SYG2	High byte - status, Low - signals
...
0x50	80	30081	MC16SYG2	High byte - status, Low - signals
0x51	81	30082	MC1SYG3	High byte - status, Low - signals
...
0x60	96	30097	MC16SYG3	High byte - status, Low - signals
0x61	97	30098	MC1SYG4	High byte - status, Low - signals
...
0x70	112	30113	MC16SYG4	High byte - status, Low - signals

Registers holding current data read from gas counters (up to 8 variables from one counter).

Start Address			Name	Description
Hex	dec	MODBUS		
0x100	256	30257	MC1VAR1_H	32 bit (H..L) floating point
0x101	257	30258	MC1VAR1_L	
0x102	258	30259	MC1VAR2_H	32 bit (H..L) floating point
0x103	259	30260	MC1VAR2_L	
0x104	260	30261	MC1VAR3_H	32 bit (H..L) floating point
0x105	261	30262	MC1VAR3_L	
...
0x10E	270	30271	MC1VAR8_H	32 bit (H..L) floating point
0x10F	271	30272	MC1VAR8_L	

0x110	272	30273	MC2VAR1_H	32 bit (H..L) floating point
0x111	273	30274	MC2VAR1_L	
...
0x11E	286	30287	MC2VAR8_H	32 bit (H..L) floating point
0x11F	287	30288	MC2VAR8_L	
...
0x1FE	510	30511	MC16VAR8_H	32 bit (H..L) floating point
0x1FF	511	30512	MC16VAR8_L	

Holding registers space

Registers threshold values HH, H, L, LL for current values. Alarm bits informing on comparison results are in binary inputs space.

Start Address			Name	Description
Hex	dec	MODBUS		
0x400	1024	41025	MC1LL1_H	LL threshold for VAR1 of counter 1
0x401	1025	41026	MC1LL1_L	32 bit (H..L) floating point
0x402	1026	41027	MC1L1_H	L threshold for VAR1 of counter 1
0x403	1027	41028	MC1L1_L	32 bit (H..L) floating point
0x404	1028	41029	MC1H1_H	H threshold for VAR1 of counter 1
0x405	1029	41030	MC1H1_L	32 bit (H..L) floating point
0x406	1030	41031	MC1HH1_H	HH threshold for VAR1 of counter 1
0x407	1031	41032	MC1HH1_L	32 bit (H..L) floating point
0x408	1032	41033	MC1LL2_H	LL threshold for VAR1 of counter 1
0x409	1033	41034	MC1LL2_L	32 bit (H..L) floating point
...
0x40E	1038	41039	MC1HH2_H	HH threshold for VAR2 of counter 1
0x40F	1039	41040	MC1HH2_L	32 bit (H..L) floating point
0x410	1040	41041	MC1LL3_H	LL threshold for VAR3 of counter 1
0x411	1041	41042	MC1LL3_L	32 bit (H..L) floating point
...
0x43E	1086	41087	MC1HH8_H	HH threshold for VAR8 of counter 1
0x43F	1087	41088	MC1HH8_L	32 bit (H..L) floating point
0x440	1088	41089	MC2LL1_H	LL threshold for VAR1 of counter 2
0x441	1089	41090	MC2LL1_L	32 bit (H..L) floating point
...
0x47E	1150	41151	MC2HH8_H	HH threshold for VAR8 of counter 2
0x47F	1151	41152	MC2HH8_L	32 bit (H..L) floating point
0x480	1152	41153	MC3LL1_H	LL threshold for VAR2 of counter 3
0x481	1153	41154	MC3LL1_L	32 bit (H..L) floating point
...
0x7FE	2046	42047	MC16HH8_H	HH threshold for VAR8 of counter 16
0x7FF	2047	42048	MC16HH8_L	32 bit (H..L) floating point

Binary outputs space

Alarm bits informing on comparison results with current values of gas counters.

Start Address			Name	Description
hex	dec	MODBUS		
0x0B8	184	10185	MC1V1LL	LL alarm bit for VAR1, counter 1
0x0B9	185	10186	MC1V1L	L alarm bit for VAR1, counter 1
0x0BA	186	10187	MC1V1H	H alarm bit for VAR1, counter 1
0x0BB	187	10188	MC1V1HH	HH alarm bit for VAR1, counter 1
0x0BC	188	10189	MC1V2LL	LL alarm bit for VAR2, counter 1
0x0BD	189	10190	MC1V2L	L alarm bit for VAR2, counter 1
0x0BE	190	10191	MC1V2H	H alarm bit for VAR2, counter 1
0x0BF	191	10192	MC1V2HH	HH alarm bit for VAR2, counter 1
0x0C0	192	10193	MC1V3LL	LL alarm bit for VAR3, counter 1

...
0x0D7	215	10216	MC1V8HH	HH alarm bit for VAR8, counter 1
0x0D8	216	10217	MC2V1LL	LL alarm bit for VAR1, counter 2
...
0x0F7	247	10248	MC2V8HH	HH alarm bit for VAR8, counter 2
0x0F8	248	10249	MC3V1LL	LL alarm bit for VAR1, counter 2
...
0x2B7	695	10696	MC16V8HH	HH alarm bit for VAR8, counter 16

Bits informing on state of communication with gas meter

Start Address			Name	Description
hex	dec	MODBUS		
0A8	168	10169	SL1_ok	1 - proper communication with counter 1
0A9	169	10170	SL2_ok	1 - proper communication with counter 2
0AA	170	10171	SL3_ok	1 - proper communication with counter 3
0AB	171	10172	SL4_ok	1 - proper communication with counter 4
0AC	172	10173	SL5_ok	1 - proper communication with counter 5
0AD	173	10174	SL6_ok	1 - proper communication with counter 6
0AE	174	10175	SL7_ok	1 - proper communication with counter 7
0AF	175	10176	SL8_ok	1 - proper communication with counter 8
0B0	176	10177	SL9_ok	1 - proper communication with counter 9
0B1	177	10178	SL10_ok	1 - proper communication with counter 10
0B2	178	10179	SL11_ok	1 - proper communication with counter 11
0B3	179	10180	SL12_ok	1 - proper communication with counter 12
0B4	180	10181	SL13_ok	1 - proper communication with counter 13
0B5	181	10182	SL14_ok	1 - proper communication with counter 14
0B6	182	10183	SL15_ok	1 - proper communication with counter 15
0B7	183	10184	SL16_ok	1 - proper communication with counter 16

13.11.6. Auxiliary resources for M-Bus mode

Input registers space

Start Address			Description
hex	dec	MODBUS	
086	134	30135	data read from the gas counter
100	256	30257	data read from counter LEC 1
140	320	30321	data read from counter LEC 2
180	384	30385	data read from counter LEC 3
1C0	448	30449	data read from counter LEC 4
200	512	30513	data read from counter LEC 5
240	576	30577	data read from counter LEC 6
280	640	30641	data read from counter LEC 7
2C0	704	30705	data read from counter LEC 8
300	768	30769	data read from counter LEC 9
340	832	30833	data read from counter LEC 10
380	896	30897	data read from counter LEC 11
3C0	960	30961	data read from counter LEC 12
400	1024	31025	data read from counter LEC 13
440	1088	31089	data read from counter LEC 14
480	1152	31153	data read from counter LEC 15
4C0	1216	31217	data read from counter LEC 16

Structure of data read from gas counter.

Offset	Type Rx[High,Low]	Description
+ 0	word 16 bit	seconds (0..59)
+ 1	word 16 bit	minutes (0..59) (tb)
+ 2	word 16 bit	hours (0..23)
+ 3	word 16 bit	day (1..31)
+ 4	word 16 bit	month (1..12)
+ 5	word 16 bit	year (2000..2099)
+ 6	float 32 bit (H,L)	Vn0 Volume [m3]
+ 8	float 32 bit (H,L)	Vn1 Volume [m3]
+ 10	float 32 bit (H,L)	Qn Flow in normal conditions [m3/h]
+ 12	float 32 bit (H,L)	Qr Flow in actual conditions [m3/h]
+ 14	float 32 bit (H,L)	P Absolute pressure [kPa]
+ 16	float 32 bit (H,L)	T Gas temperature [°C]
+ 18	float 32 bit (H,L)	F Correction coefficient
+ 20	float 32 bit (H,L)	K1 Compression coefficient
Volume at the beginning of hour or after establishing the communication for calculation of hourly flow.		
+ 22	word 16 bit	seconds (0..59)
+ 23	word 16 bit	minutes (0..59) (th)
+ 24	word 16 bit	hours (0..23)
+ 25	word 16 bit	day (1..31)
+ 26	word 16 bit	month (1..12)
+ 27	word 16 bit	year (2000..2099)
+ 28	float 32 bit (H,L)	Vh0 Volume [m3]
+ 30	float 32 bit (H,L)	Vh1 Volume [m3]
+ 32	word 16 bit	Vh Flow at beginning of hour [m3] $Vn10 = Vn1 * 1e4 + Vn0$ $Vh10 = Vh1 * 1e4 + Vh0$ $Vh = (Vn10 - Vh10)$
+ 33	word 16 bit	Qh hourly flow in current hour [m3/h] $Qh = Vh + Qhp * (60 - tb + th) / 60$
+34	word 16 bit	Qhp flow in previous hour [m3]

Structure of input data read from heat meter

Offset	Type Rx[High,Low]	Description	
+ 0	4 bytes R0[LL,L], R1[H,HH]	Ident. Nr	Header of received MBUS frame
+ 2	2 bytes R2[L,H]	Manufacture	
+ 3	2 bytes R3[Version,Medium]	Version + Medium	
+ 4	2 bytes R4[Access,Status]	Access Nr + Status	
+ 5	2 bytes R5[L,H]	Signature	
+ 6	dword 32 bit (H,L)	LEC - timestamp	LEC - timestamp
+ 8	dword 32 bit (H,L)	LEC - errorflag	LEC - error flags
+ 10	word 16 bit	seconds (0..59)	MT101 - timestamp
+ 11	word 16 bit	minutes (0..59)	
+ 12	word 16 bit	hours (0..23)	
+ 13	word 16 bit	day of week (1..7)	
+ 14	word 16 bit	day (1..31)	
+ 15	word 16 bit	month (1..12)	

Offset	Type Rx[High,Low]	Description
+ 16	word 16 bit	year (2000..2099)
+ 17	word 16 bit	high bits inform, which fields were read in current frame.
+ 18	float 32 bit (H,L), 0001	Temperature of supply flow [°C]
+ 20	float 32 bit (H,L), 0002	Temperature of return flow [°C]
+ 22	float 32 bit (H,L), 0004	Flow [m3/h]
+ 24	float 32 bit (H,L), 0008	Effect [W]
+ 26	float 32 bit (H,L), 0010	Volume [m3]
+ 28	float 32 bit (H,L), 0020	Energy [J]
+ 30	float 32 bit (H,L), 0040	Working time [h]
+ 32	float 32 bit (H,L), 0080	Auxiliary water meter 1 [m3]
+ 34	float 32 bit (H,L), 0100	Auxiliary water meter 2 [m3]
+ 36	float 32 bit (H,L), 0200	Auxiliary water meter 3 [m3]
+ 38	float 32 bit (H,L), 0400	Auxiliary water meter 4 [m3]
+ 40	float 32 bit (H,L), 0800	Max flow [m3/h]
+ 42	float 32 bit (H,L), 1000	Max effect [W]
+ 44	float 32 bit (H,L), 2000	Reserved for
+ 46	float 32 bit (H,L), 4000	Reserved for
+ 48	float 32 bit (H,L), 8000	Reserved for
+ 50	dword 32 bit (H,L)	"Identification Number" from frame header in binary form, read from heat meter
+ 52	dword 32 bit (H,L)	"Identification Number" assigned during MT module configuration
+54	word 16 bit	Temperature of supply flow[x10 °C]
+55	word 16 bit	Temperature of return flow[x10 °C]

Holding registers space

Alarm thresholds placement (float type variables 32 bit HL, 2 Registers)

Start Address			Description
hex	dec	MODBUS	
400	1024	41025	LEC1, lower threshold - Supply temp. [°C]
402	1026	41027	LEC1, upper threshold - Supply temp. [°C]
404	1028	41029	LEC1, lower threshold - Return temp. [°C]
406	1030	41031	LEC1, upper threshold - Return temp. [°C]
408	1032	41033	LEC1, lower threshold - Flow [m3/h]
40A	1034	41035	LEC1, upper threshold - Flow [m3/h]
40C	1036	41037	LEC1, lower threshold - Effect [W]
40E	1038	41039	LEC1, upper threshold - Effect [W]
410	1040	41041	LEC1, lower threshold - Volume [m3]
412	1042	41043	LEC1, upper threshold - Volume [m3]
414	1044	41045	LEC1, lower threshold - Energy [J]
416	1046	41047	LEC1, upper threshold- Energy [J]
418	1048	41049	LEC1, lower threshold - Working time [h]
41A	1050	41051	LEC1, upper threshold - Working time [h]
41C	1052	41053	LEC1, Alarm hourly consumption for Aux. water meter 1 [m3/h]
41E	1054	41055	LEC1, upper threshold - Auxiliary water meter 1 [m3]
420	1056	41057	LEC1, Alarm hourly consumption for Aux. water meter 2 [m3/h]
422	1058	41059	LEC1, upper threshold - Auxiliary water meter 2 [m3]
424	1060	41061	LEC1, Alarm hourly consumption for Aux. water meter 3 [m3/h]
426	1062	41063	LEC1, upper threshold - Auxiliary water meter 3 [m3]

Start Address			Description
hex	dec	MODBUS	
428	1064	41065	LEC1, Alarm hourly consumption for Aux. water meter 4 [m3/h]
42A	1066	41067	LEC1, upper threshold - Auxiliary water meter 4 [m3]
42C	1068	41069	LEC1, lower threshold - Max flow [m3/h]
42E	1070	41071	LEC1, upper threshold - Max flow [m3/h]
430	1072	41073	LEC1, lower threshold - Max effect [W]
432	1074	41075	LEC1, upper threshold - Max effect [W]
434	1076	41077	Reserved for
436	1078	41079	Reserved for
438	1080	41081	Reserved for
43A	1082	41083	Reserved for
43C	1084	41085	Reserved for
43E	1086	41087	Reserved for
440..	1088..	41089..	LEC2
480..	1152..	41153..	LEC3
4C0..	1216..	41217..	LEC4
500..	1280..	41281..	LEC5
540..	1344..	41345..	LEC6
580..	1408..	41409..	LEC7
5C0..	1472..	41473..	LEC8
600..	1536..	41537..	LEC9
640..	1600..	41601..	LEC10
680..	1664..	41665..	LEC11
6C0..	1728..	41729..	LEC12
700..	1792..	41793..	LEC13
740..	1856..	41857..	LEC14
780..	1920..	41921..	LEC15
7C0..	1984..	41985..	LEC16

Binary inputs space
Alarm bits placement

Start Address			Description
hex	dec	MODBUS	
bits informing on status of communication with heat counters			
0A8	168	10169	proper communication with counter 1 (SL1_ok)
0A9	169	10170	proper communication with counter 2 (SL2_ok)
0AA	170	10171	proper communication with counter 3 (SL3_ok)
0AB	171	10172	proper communication with counter 4 (SL4_ok)
0AC	172	10173	proper communication with counter 5 (SL5_ok)
0AD	173	10174	proper communication with counter 6 (SL6_ok)
0AE	174	10175	proper communication with counter 7 (SL7_ok)
0AF	175	10176	proper communication with counter 8 (SL8_ok)
0B0	176	10177	proper communication with counter 9 (SL9_ok)
0B1	177	10178	proper communication with counter 10 (SL10_ok)
0B2	178	10179	proper communication with counter 11 (SL11_ok)
0B3	179	10180	proper communication with counter 12 (SL12_ok)
0B4	180	10181	proper communication with counter 13 (SL13_ok)
0B5	181	10182	proper communication with counter 14 (SL14_ok)
0B6	182	10183	proper communication with counter 15 (SL15_ok)
0B7	183	10184	proper communication with counter 16 (SL16_ok)
alarm bits for heat consumption meters			
0B8	184	10185	LEC1, lower threshold - Supply temp. [°C]
0B9	185	10186	LEC1, upper threshold - Supply temp. [°C]

Start Address			Description
hex	dec	MODBUS	
0BA	186	10187	LEC1, lower threshold- Return temp. [°C]
0BB	187	10188	LEC1, upper threshold - Return temp. [°C]
0BC	188	10189	LEC1, lower threshold - Flow [m3/h]
0BD	189	10190	LEC1, upper threshold - Flow [m3/h]
0BE	190	10191	LEC1, lower threshold - Effect [W]
0BF	191	10192	LEC1, upper threshold - Effect [W]
0C0	192	10193	LEC1, lower threshold - Volume [m3]
0C1	193	10194	LEC1, upper threshold - Volume [m3]
0C2	194	10195	LEC1, lower threshold - Energy [J]
0C3	195	10196	LEC1, upper threshold - Energy [J]
0C4	196	10197	LEC1, lower threshold - Working time [h]
0C5	197	10198	LEC1, upper threshold - Working time [h]
0C6	198	10199	Reserved for
0C7	199	10200	LEC1, upper threshold - Auxiliary water meter 1 [m3]
0C8	200	10201	Reserved for
0C9	201	10202	LEC1, upper threshold - Auxiliary water meter 2 [m3]
0CA	202	10203	Reserved for
0CB	203	10204	LEC1, upper threshold - Auxiliary water meter 3 [m3]
0CC	204	10205	Reserved for
0CD	205	10206	LEC1, upper threshold - Auxiliary water meter 4 [m3]
0CE	206	10207	LEC1, lower threshold - Max. flow [m3/h]
0CF	207	10208	LEC1, upper threshold - Max. flow [m3/h]
0D0	208	10209	LEC1, lower threshold - Max. effect [W]
0D1	209	10210	LEC1, upper threshold - Max. effect [W]
0D2	210	10211	Reserved for
0D3	211	10212	Reserved for
0D4	212	10213	Reserved for
0D5	213	10214	Reserved for
0D6	214	10215	Reserved for
0D7	215	10216	Reserved for
0D8..	216..	10217..	LEC2
0F8..	248..	10249..	LEC3
118..	280..	10281..	LEC4
138..	312..	10313..	LEC5
158..	344..	10345..	LEC6
178..	376..	10377..	LEC7
198..	408..	10409..	LEC8
1A8..	440..	10441..	LEC9
1C8..	472..	10473..	LEC10
1E8..	504..	10505..	LEC11
218..	536..	10537..	LEC12
238..	568..	10569..	LEC13
258..	600..	10601..	LEC14
278..	632..	10633..	LEC15
298..	664..	10665..	LEC16
alarm and information bits for GAZMODEM (configuration port)			
3B8	952	10953	proper communication with gas counter

13.11.7. Auxiliary resources of NMEA 0183 mode

Binary outputs space information bits

Address of bit			Register address	Description	Validity register Address.bit
Hex	dec	MODBUS			
0x80	128	129	0x402	Latitude	0x401.0
0x81	129	130	0x404	Longitude	0x401.1
0x82	130	131	0x406	Altitude over sea level	0x401.2
0x83	131	132	0x408	Speed Over Ground	0x401.3
0x84	132	133	0x40A	Course Over Ground	0x401.4
0x85	133	134	0x40C	Number of used satellites	0x401.5
0x86	134	135	0x40E	Atmospheric pressure	0x401.6
0x87	135	136	0x410	Air temperature	0x401.7
0x88	136	137	0x412	Relative humidity	0x401.8
0x89	137	138	0x414	Dew point	0x401.9
0x8A	138	139	0x416	Wind direction	0x401.10
0x8B	139	140	0x418	Wind speed	0x401.11
0x8C	140	141	0x41A	Relative wind direction	0x401.12
0x8D	141	142	0x41C	Relative wind speed	0x401.13
0x8E	142	143	0x41E	Theoretical wind direction	0x401.14
0x8F	143	144	0x420	Theoretical wind speed	0x401.15
0x90	144	145	0x422	Relative wind chill factor	0x400.0
0x91	145	146	0x424	Theoretical wind chill factor	0x400.1

Reading values from NMEA frame and recording it to Register is marked by setting of corresponding bit. Users wanting to detect new recording have to reset respective bit and await consecutive setting it to 1 marking a new recording into corresponding register.

Holding registers space

Mentioned Registers hold information read from NMEA frames.

All values are stored in 2 16 bit registers in form of 32 bit signed integer, scaled appropriately for storing decimal values. Registers are ordered in HL order, which is High 16 bits are placed in first register (with lower address).

Example 1:

The value 1234 in register representing numbers with 2 decimals FIX(2) will be recorded as integer value 123400.

After conversion to 16 bit form = 0x1E208

RegH = 0x0001 (1)

RegL = 0xE208 (57862)

Example 2:

Value -10,3 FIX(1)

Integer value in 32 bit register = -103

After conversion to 16 bit form = 0xFFFFF99

RegH = 0xFFFF (65535)

RegL = 0xFF99 (65433)

Description registers

Addresses in tables point to placement of first register holding High order word of the number. Low order word lays in next register.

Address	0x400 (1024)	Register of validity of NMEA variables
	Modbus (41025)	

This register is used to control whether values read from NMEA frames held in registers are valid (up to date).

A High bit signals that data in corresponding register is valid, while Low bit signals that register holds outdated data. This bit is set High each time the value is written to corresponding register and reset when data is older than defined during module configuration time of signaling variables validity.

Bit assignment is described in information bits table

Address	0x402 (1026)	Latitude
	Modbus (41027)	
Format 1	FIX(5)	degrees (S), minutes (M), fractions of minute (m) [SSMM.mmmmm]
Format 2	FIX(7)	degrees (S), fractions of degrees (s) [SS.ssssss]
Frames	\$GPRMC, \$GPGGA, \$GPGLL,	

Latitude North is represented by positive number while South is represented by negative number.

Address	0x404 (1028)	Longitude
	Modbus (41029)	
Format 1	FIX(5)	degrees (S), minutes (M), fractions of minute (m) [SSSMM.mmmmm]
Format 2	FIX(7)	degrees (S), fractions of degrees (s) [SSS.ssssss]
Frames	\$GPRMC, \$GPGGA, \$GPGLL	

Longitude East is represented by positive number while West is represented by negative number.

Address	0x406 (1030)	Altitude above sea level
	Modbus (41031)	
Format	FIX(1)	Unit meter [m]
Frames	\$GPGGA	
Address	0x408 (1032)	Speed Over Ground
	Modbus (41033)	
Format	FIX(1)	Unit kilometers/hour [km/h]
Frames	\$GPRMC, \$GPVTG	
Address	0x40A (1034)	Course Over Ground
	Modbus (41035)	
Format	FIX(1)	Unit degrees[° True]
Frames	\$GPRMC, \$GPVTG	
Address	0x40C (1036)	Number of satellites in use
	Modbus (41037)	
Format	FIX(0)	
Frames	\$GPGGA	
Address	0x40E (1038)	Barometric pressure
	Modbus (41039)	
Format	FIX(0)	Unit [hPa]
Frames	\$WIMDA	

Address	0x410 (1040)	Air temperature
	Modbus (41041)	
Format	FIX(1)	Unit degrees Celsius [°C]
Frames	\$WIMDA	
Address	0x412 (1042)	Relative humidity
	Modbus (41043)	
Format	FIX(1)	Unit [%]
Frames	\$WIMDA	
Address	0x414 (1044)	Dew point
	Modbus (41045)	
Format	FIX(1)	Unit degrees Celsius [°C]
Frames	\$WIMDA	
Address	0x416 (1046)	Wind direction
	Modbus (41047)	
Format	FIX(1)	Unit degrees[°C]
Frames	\$WIMDA, \$WIMWD	
Address	0x418 (1048)	Wind speed
	Modbus (41049)	
Format	FIX(1)	Unit kilometers/hour [km/h]
Frames	\$WIMDA, \$WIMWD	
Address	0x41A (1050)	Relative wind direction
	Modbus (41051)	
Format	FIX(1)	Unit degrees [°]
Frames	\$WIMWV (relative)	
Address	0x41C (1052)	Relative wind speed
	Modbus (41053)	
Format	FIX(1)	Unit kilometers/hour[km/h]
Frames	\$WIMWV (relative)	
Address	0x41E (1054)	Theoretical wind direction
	Modbus (41055)	
Format	FIX(1)	Unit degrees [°]
Frames	\$WIMWV (theoretical)	

Address	0x420 (1056)	Theoretical wind speed
	Modbus (41057)	
Format	FIX(1)	Unit kilometers/hour [km/h]
Frames	\$WIMWV (theoretical)	
Address	0x422 (1058)	Relative wind chill temperature
	Modbus (41059)	
Format	FIX(1)	Unit degrees [°]
Frames	\$WIXDR	
Address	0x424 (1060)	Theoretical wind chill temperature
	Modbus (41061)	
Format	FIX(1)	Unit degrees [°]
Frames	\$WIXDR	